

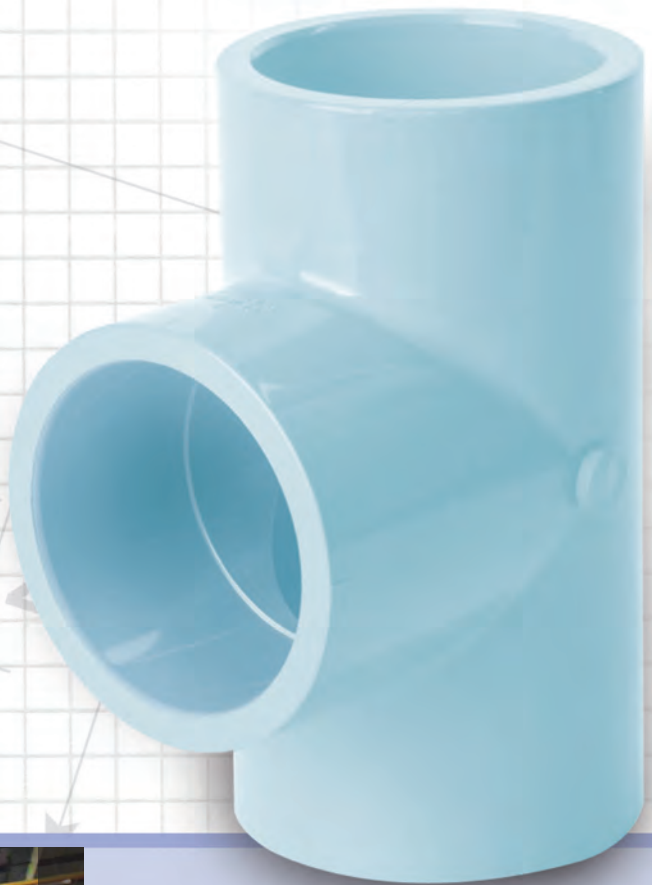

## Pipes, Fittings & Valves

Metric System

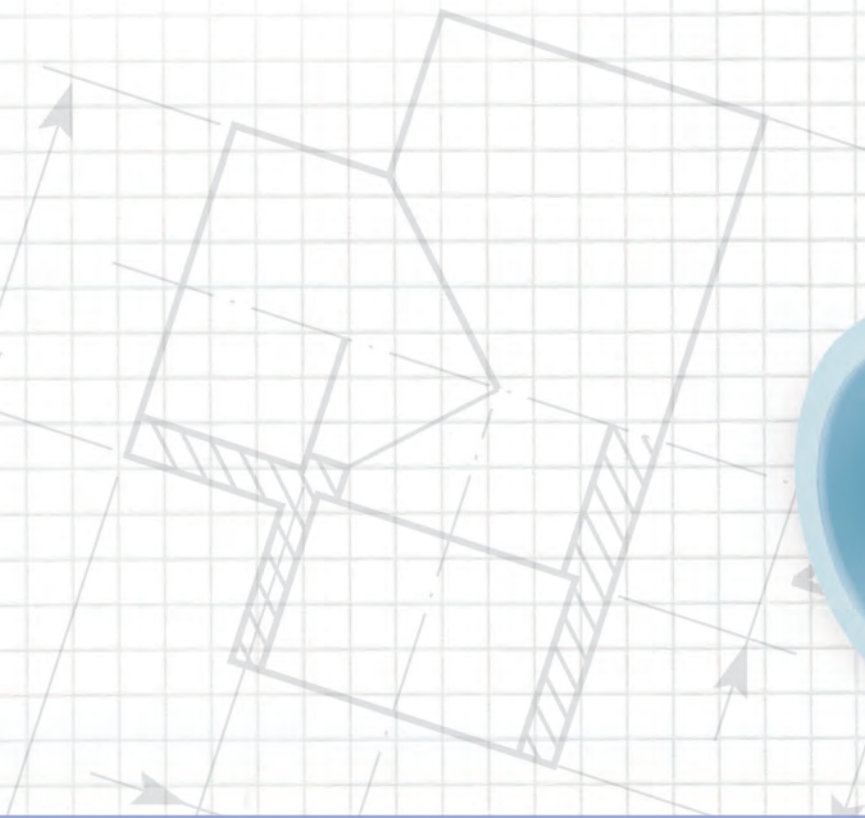

Durapipe Air-Line Xtra

# Technical Data

Durapipe  
**Air-Line Xtra**  
Compressed Air Distribution

## COMPRESSED AIR DISTRIBUTION

**Durapipe Air-Line Xtra is the ideal solution for ensuring that air is kept clean and uncontaminated for use in process and manufacturing industries.**

A lightweight, non-corrodible compressed air distribution system, Durapipe Air-Line Xtra is manufactured from a specially formulated blend of ABS and is suitable for continuous operation at 12.5 bar at 20°C.

Boasting a 30-year design life, Durapipe Air-Line Xtra is specifically designed for the conveyance of compressed air. Air-Line Xtra also meets the requirements of the UK Pressure Systems and Transportable Container Regulations.



### Key Product Information

- Size Range: 16mm to 110mm
- Pressure Rating: PN12.5

### Key Product Features

- Lightweight
- Easy to install
- Ultra smooth internal bore
- Corrosion resistant

### Typical Applications

- Compressed air systems



# Air-Line Xtra

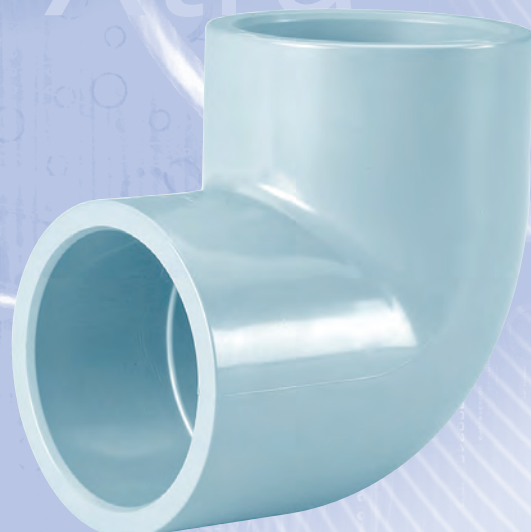

# Air-Line Xtra

## Contents

	page
<b>Durapipe Air-Line Xtra Introduction .....</b>	<b>4</b>
<b>The System.....</b>	<b>5</b>
<b>Case Study Examples.....</b>	<b>6</b>
<b>Technical Information</b>	
<b>Design and Installation.....</b>	<b>7-17</b>
<b>Installation Guide .....</b>	<b>18-19</b>
<b>Jointing Methods .....</b>	<b>20-21</b>
<b>Safety Precautions.....</b>	<b>22</b>
<b>General Information .....</b>	<b>22</b>
<b>Compressor Oil Suitability.....</b>	<b>23-24</b>
<b>Index to Air-Line Xtra Imperial Fittings</b>	
Pipe .....	26
Sockets.....	26
Reducing bushes .....	26
Reducers .....	27
Elbows 45° .....	27
Elbows 90° .....	27
Bends 90°.....	27
Dropper bends 180°.....	28
Tees 90° equal .....	28
Tees 90° reducing.....	28
End caps.....	28
Socket unions.....	29
Sockets.....	29
Female threaded adaptors.....	29
Female composite unions.....	29
Male composite unions .....	30
Wall brackets .....	30
Wall brackets - Multiport .....	30
Flanges stub.....	30
Flanges blanking.....	31
Backing rings.....	31
Gaskets flat .....	31
Flange assembly kits .....	31
Valve support plates.....	31
<b>Valves</b>	
VKD Double union ball valves.....	32
FK Butterfly valves .....	32
VM Diaphragm valves.....	32
<b>Accessories</b>	
Cobra pipe clips.....	33
Air-Line Xtra solvent cement.....	33
Eco cleaner .....	33
Chamfering and de-burring tools .....	33
Pipe cutters.....	33
<b>Durapipe UK Pipework Systems.....</b>	<b>34</b>
<b>Conditions of Sale.....</b>	<b>35</b>

## Durapipe Air-Line Xtra Introduction

### What is Air-Line Xtra?

Compressed air, a major source of industrial energy, is being used increasingly in both the manufacturing and process industries where its distinct advantages of cleanliness, flexibility, safety and economy of use, compared with other energy sources, are fully exploited.

Modern process equipment, pneumatic controls and instrumentation, however, demand a supply of clean, uncontaminated air, and this has necessitated the development in recent years of more advanced designs of compressors and ancillary equipment.

Maintenance of the cleanliness of this air, from source right up to the point of use is obviously essential. Hence air mains and branch lines are also required to be of an advanced design.

Durapipe Air-Line Xtra is a lightweight, non-corrodible compressed air distribution system from Durapipe pipe systems. Durapipe Air-Line Xtra offers a wider field of applications and additional benefits.

Durapipe Air-Line Xtra is also fully acceptable under the UK, 'Pressure Systems and Transportable Gas Container Regulations'.

Manufactured from a specially formulated ABS blend, Durapipe Air-Line Xtra pipe has a

high performance co-extruded liner which greatly enhances its mechanical and chemical properties. Durapipe Air-Line Xtra fittings are manufactured using an alloy blend of ABS which ensures that the performance of the whole system is without equal.

The system is designed specifically for the conveyance of compressed air and with its unrivalled properties becomes the ideal choice for critical applications.



**DURAPIPE AIR-LINE XTRA KEEPS  
AIR CLEAN – RIGHT UP TO THE POINT OF USE.**

### The advantages of Durapipe Air-Line Xtra pipework systems are:

- **Safety**

The Butadiene constituent of Durapipe Air-Line Xtra affords resistance to accidental damage and prevents material fracture should the pipe be subjected to severe impact, even at sub-zero temperatures. Durapipe Air-Line Xtra has a design life of 30 years with a residual factor of safety of 2:1.

- **Wide range of applications**

The advanced liner and material combination protects against the stray chemicals which can sometimes cause problems for ordinary systems. Now compatible with even more compressor lubricants, Durapipe Air-Line Xtra pipes and fittings carry a DIN 4102-B2 fire rating.

- **Clean**

Strong packaging protects the surface finish of pipe and fittings and prevents contamination before use. The smooth, hygienic liner is impressively clean when new and cannot rust, corrode or form loose scale. Clean air remains clean throughout the life of the system.

- **Non-toxic**

Durapipe Air-Line Xtra has been proved to be safe for both medical and everyday applications.

- **Smooth bore**

Less friction means lower pressure drops and higher flow rates – this may allow smaller pipes to be used.

- **Easy to handle**

One sixth of the weight of steel.

- **Quick to joint**

No threading required – jointed by cold solvent welding. Easy on-site modification and repair.

- **Speed of installation**

No special equipment or special skills required.

- **Leak-free system**

Leakage cannot occur from a correctly made solvent welded joint, greatly reducing running costs.

- **Self coloured and maintenance free**

Light blue in accordance with British Standards requirements BS 4800 and BS 1710. No painting or maintenance necessary.

- **Acceptable under UK regulations**

Further details of the UK 'Pressure Systems and Transportable Gas Container Regulations' are available on request.

- **Proven**

Durapipe Air-Line systems have been giving satisfactory service since 1976.

### Quality

All pipes, fittings and valves are manufactured in an environment operating a quality system which has been successfully assessed to BS EN ISO 9001.



As part of this Quality System both raw materials and finished Durapipe Air-Line Xtra products are subjected to rigorous quality control tests. In addition, long-term pressure tests, together with ageing, weathering and stressed environmental tests are carried out to ensure complete system integrity over the designed operating life.

### Environment

We also operate an environmental management system that has been successfully assessed against BS EN ISO 14001 environmental management standard.

## The System

### ABS Material

Acrylonitrile-Butadiene-Styrene (ABS) identifies a broad family of engineering thermoplastics with a range of performance characteristics.

This copolymeric material can be blended to yield the optimum balance of properties suited to a selected end use.

Acrylonitrile imparts chemical resistance and rigidity, the Butadiene constituent gives the material impact strength and toughness, whilst Styrene contributes to ease of processing and good surface finish.

The formulation used for Durapipe Air-Line Xtra has been selected to optimise performance in respect of tensile strength, toughness, ductility, heat stability and processability from raw material to finished product. These properties make it suitable for conveying compressed air.

ABS has good chemical resistance and is easily joined by solvent welding which allows fast system assembly and modification.

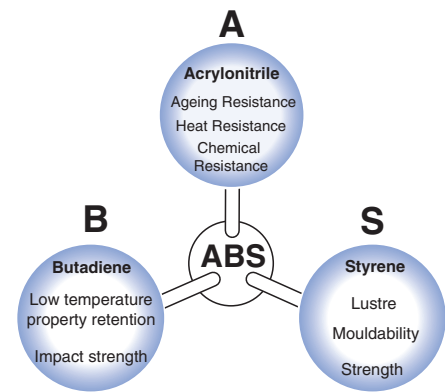

### The System

Advanced manufacturing techniques allow the formation of a liner layer in the pipe bore. The liner is a high performance copolymeric material which offers extra strength (because it is permanently fused with the outer, ABS layer during the extrusion process) together with an unrivalled level of chemical resistance.

Fittings are produced in an alloy blend of ABS and the liner material which has been carefully balanced to achieve a performance improvement to match the new pipe.

In common with ABS materials, Durapipe Air-Line Xtra can suffer stress attack if exposed to some compressor oils. A list of suitable oils is shown on pages 23-24. If in doubt always check before installation. The system offers resistance to the stray aggressive substances which can sometimes contaminate compressed air pipelines and which can cause problems for other thermoplastic materials.

Durapipe Air-Line Xtra retains the simplicity and strength of ABS welded joints. It is a system which offers reliability and durability even in the most arduous operating environment.

### Valves

Double union ball valves, diaphragm valves and butterfly valves are available for use with the Durapipe Air-Line Xtra system, and are featured on page 32.

### Tough and Durable

Durapipe Air-Line Xtra is made from a specially blended ABS material which makes the system extremely tough and durable with great levels of impact resistance when compared to other compressed air distribution materials.

### Operational Range

The Durapipe Air-Line Xtra system is designed for a maximum continuous service pressure of 12.5 bar at 20°C. Any increase in working temperature above 20°C will necessitate a corresponding reduction in pressure rating as detailed on page 8.

### Size Range

The Durapipe Air-Line Xtra range is produced in the following metric sizes: 16, 20, 25, 32, 40, 50, 63, 75, 90 and 110mm. It should be noted that these are outside diameters – pipes being sized and designated by the outside diameter. For convenience the equivalent sizes of Durapipe Air-Line Xtra, galvanised mild steel and copper are compared in the table below.

**Note:** The smooth bore of Durapipe Air-Line Xtra pipes and fittings allows a smaller pipe to be used for a given air flow – refer to page 10.

Air-Line Xtra		Galvanised mild-steel BS 1387				Copper	
Nominal o/d mm	12.5 bar weight kg/m	Nominal bore in	Actual o/d mm	Light weight kg/m	Heavy weight kg/m	BS 2871 pt 1 table x Actual o/d mm	weight kg/m
16	0.1	3/8	17.2	0.67	0.69	15.00	0.28
20	0.13	1/2	21.3	0.95	1.45	18.00	0.38
25	0.18	3/4	26.9	1.41	1.90	22.00	0.53
32	0.28	1	33.7	2.01	2.97	28.00	0.68
40	0.46	1 1/4	42.4	3.14	3.84	35.00	1.11
50	0.69	1 1/2	48.3	3.25	4.43	42.00	1.37
63	1.09	2	60.3	4.11	6.17	54.00	1.77
75	1.54	2 1/2	76.1	5.80	7.90	67.00	2.23
90	2.23	3	88.9	6.81	10.10	76.10	3.13
110	3.31	4	114.3	9.89	14.40	108.00	4.47

**Note:** 'Light' as shown in the table is a British Standard 1387 description.

### Technical Support

From manufacture to marketplace, Durapipe Air-Line Xtra is supported by the technical experience gained over four decades of thermoplastics pressure pipework production.

Durapipe Air-Line Xtra is supported by our own Research and Development facilities plus a team of specialist Technical Support Engineers, which is readily available to give its expert advice on any aspect of the product.

This Users Guide serves to outline the design and installation techniques required to achieve a safe, high integrity system. Further details can be obtained from our Technical Support Department.

## Factory Services

### Packaging Factory

#### Application: Compressed Air

“Durapipe Air-Line Xtra is very quick and easy to install, which saved us significant time during the installation process, whilst the performance of the system has been exceptional to date.”

*Isaac Wilkinson,  
Ellison Energy*



## Water Treatment

### Effluent Treatment

#### Application: Aeration Beds

“The team at Durapipe provided excellent service from the initial enquiry, continuing throughout the installation process. Due to the nature of the application, we had very specific criteria.”

*Mike Back,  
Damar Group*



## Air-Line Xtra Case Study Examples

## Manufacturing

### Electrical Manufacturing Plant

#### Application: Compressed Air

“We needed a product that is reliable, long lasting and low maintenance, Durapipe Air-Line Xtra is a lightweight, non-corrodible compressed air distribution system with a 30 year design life.”

*Des McNally,  
Sematek UK*



## Food & Beverage Processing

### Food Development Plant

#### Application: Compressed Air

“The system was installed to transport compressed air throughout the plant to all 130 pieces of cleaning equipment in order to ensure that the building remains thoroughly uncontaminated.”

*Andy Crawford,  
Mechanical Services Ltd*

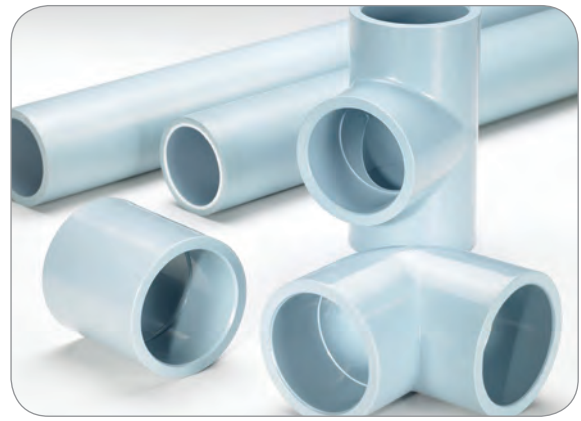

## Technical Information

### Design and Installation

#### Dimensions and standards

The outside diameters of the pipes comply with the dimensional requirements of DIN 8062, and ISO 161/1. The socket sizes of the fittings conform with the dimensional requirements of DIN 8063 and ISO 727. The sockets of the fittings have a 0° 30' taper, the diameter decreasing from the mouth to the root. All dimensions in this brochure are shown in millimetres with the exception of threaded fittings which conform to the nominal requirements of BS 21, DIN 2999 Part 1 and ISO 7 Part 1. All Durapipe Air-Line Xtra threaded fittings have taper threads with the exceptions of the female composite unions, the inlet to the multiport wall bracket. The table below shows the socket dimensions for the whole range.

Ød <sub>1</sub>	NW	A	B	
			Min	Max
16	10	14	16.1	16.3
20	15	16	20.1	20.3
25	20	18.5	25.1	25.3
32	25	22	32.1	32.3
40	32	26	40.1	40.3
50	40	31	50.1	50.3
63	50	37.5	63.1	63.3
75	65	43.5	75.1	75.3
90	80	51	90.1	90.3
110	100	61	110.1	110.4

- Ød<sub>1</sub> = Pipe outside diameter
- NW = Nominal bore
- A = Minimum socket depth
- B = Mid mean socket diameter at mid mean point of socket depth.

#### Z-length installation methods

As an aid to installation, Z-lengths have been added to the dimensional details of fittings shown in this section. The basic idea is to assist in the prefabrication of pipe sections and to avoid time consuming and costly piecemeal preparation of short lengths and fittings on an individual basis. By using Z-lengths, as many measurements as possible are taken at one time and pipe sections can be readily pre-assembled away from the job site.

To fabricate pipe assemblies from sketches giving centre-line dimensions it is necessary to know the distance from the perpendicular centre line of the fitting to the beginning of the pipe and in the case of sockets and similar fittings, the pipe stop length. These are the 'Z-lengths' and are the key to easy fabrication.

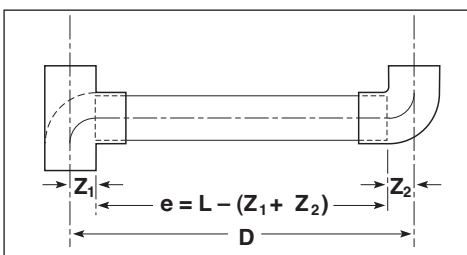

By subtracting the sum of the Z dimensions of the two fittings from the centre-to-centre measurement, the length of pipe required can be quickly determined. Thus the cutting length required (e), is obtained by subtracting the sum of the 2 lengths (Z<sub>1</sub> + Z<sub>2</sub>), from the centre-line measurement (L).

#### Reducing sockets

Durapipe Air-Line Xtra reducers incorporate 3 controlled diameters offering a wider range than usual for each fitting, see page 21. The smaller end is socketed only, whilst the larger end can be used either as a spigot or a socket.

#### Adaptor pipe fittings

Female threaded adaptors incorporate 2 controlled diameters on the plain end and can be used as spigot or socket, giving a wider range of use than usual, see page 21.

#### Marking

Most Durapipe Air-Line Xtra fittings incorporate the following information moulded on during manufacture. Other fittings are marked by printing.

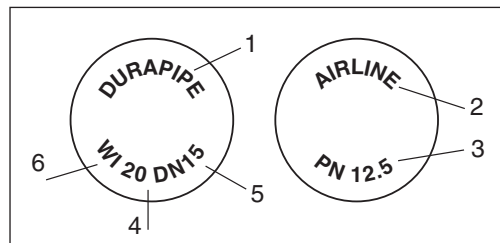

1. Name or Trade Mark: Durapipe or DF
2. Material: Co-polymer ABS
3. Pressure Rating: PN 12.5
4. Size
5. Nominal Bore
6. DIN Standard form designation mark e.g. W1 – 90° elbow

#### Standard pack

The Standard Pack quantity for each size of fitting is shown in this brochure under the heading SP. The standard length of pipe denoted under SL.

#### Weight

The weight of the fittings in grams is shown in the appropriate column for each fitting.

**Pressure temperature parameters – Air-Line Xtra**

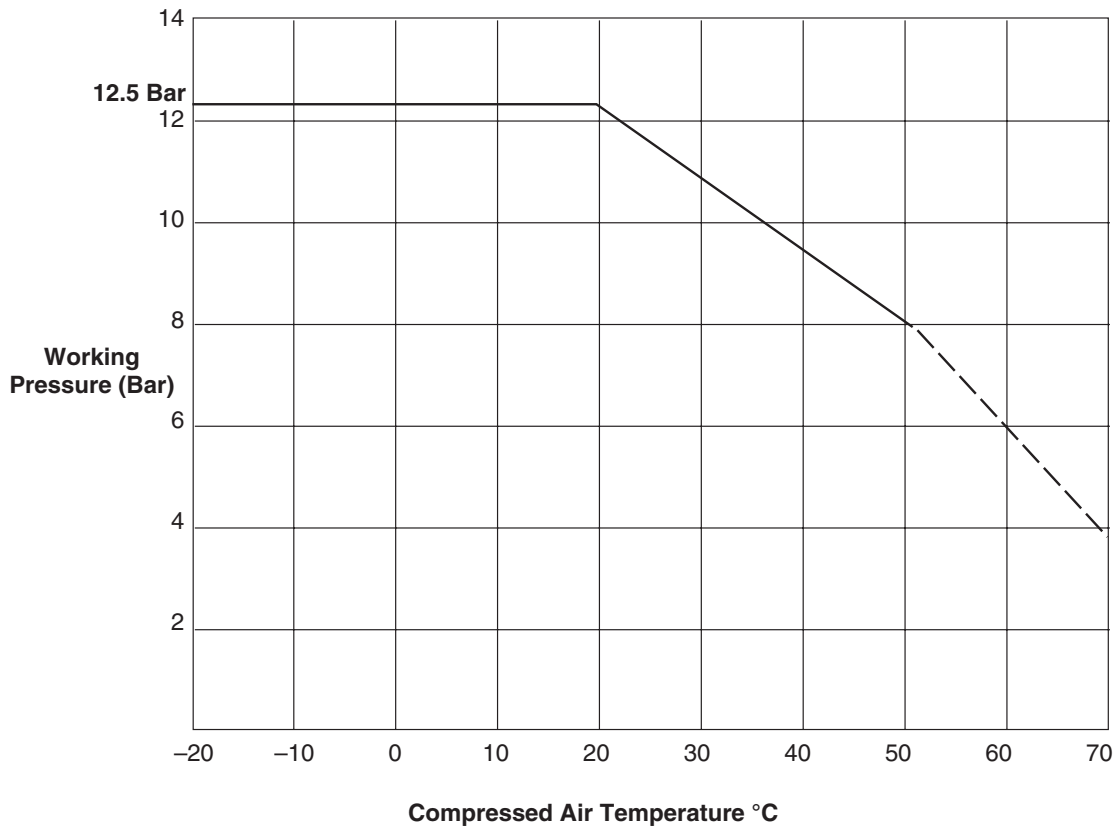

**Pressure/Temperature parameters**

The maximum continuous working pressure of the PN12.5 Durapipe Air-Line Xtra system is 12.5 bar at 20°C.

This pressure must not be continuously exceeded or a reduced service life will result.

Transient increases in pressure can be tolerated up to a maximum of 10% over the maximum continuous pressure at a given temperature.

For increased compressed air temperatures the pressure rating of Durapipe Air-Line Xtra should be correspondingly reduced, as indicated in the graph above. For example, at 50°C the PN 12.5 system can be operated continuously up to 8 bar internal pressure.

**Notes:**

1. Graphs are based on an ambient temperature of 20°C.
2. For higher ambient temperatures decrease the working pressure by 5% for every 10°C above 20°C ambient.
3. Generally Durapipe Air-Line Xtra systems must not be used at temperatures below -20°C or in excess of 50°C. For applications between 50°C and 60°C consult our Technical Support Department on +44 (0)1543 471681.



## Durapipe Air-Line Xtra Nomogram – for pressure drop and flow rate in compressed air pipework

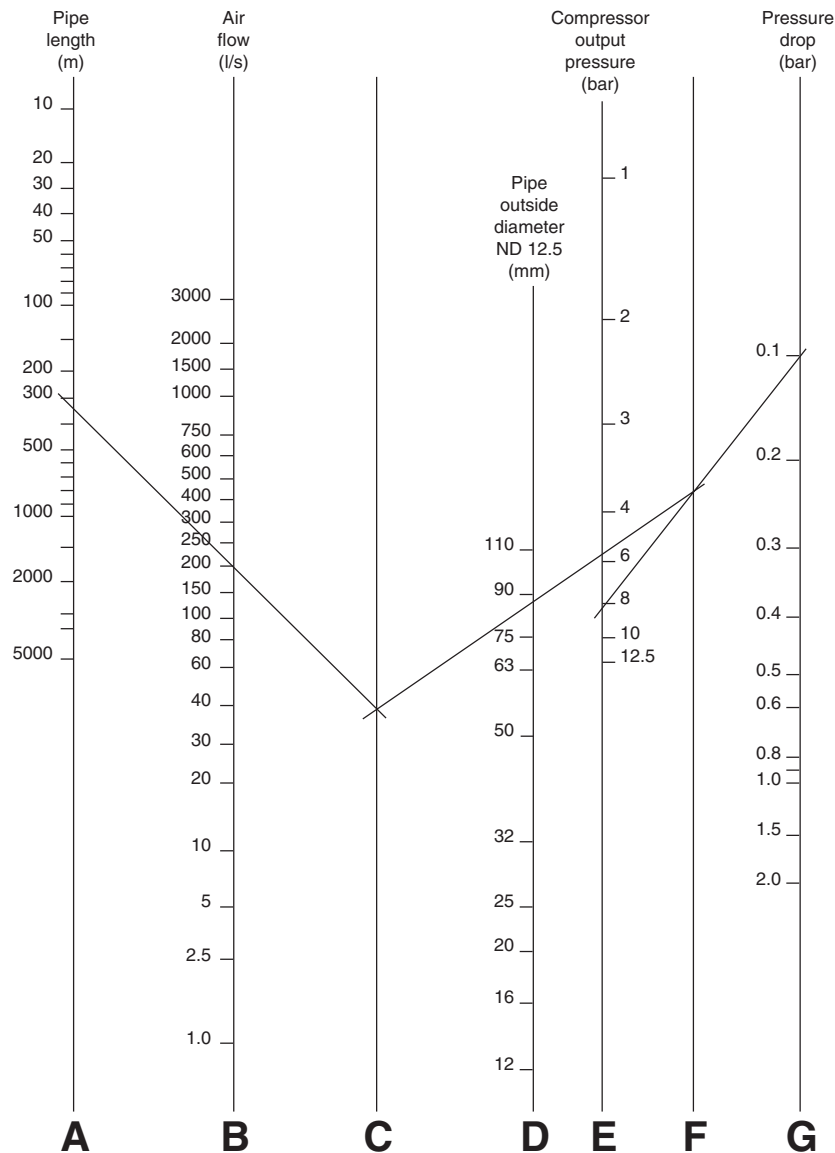

### Durapipe Air-Line Xtra Nomogram

The pressure drop tables published previously have now been replaced by a nomogram based on the Standard Isothermal Compressible flow formula and designed to give a quick and easy read off situation. The nomogram is not intended to give absolutely precise information, however it does provide an acceptable means of determining pipe sizes which are sufficiently accurate for the majority of industrial systems. A worked example is shown with the values being plotted on the small nomogram to illustrate its correct use. Copies of an A4 size nomogram are available upon request, for use in determining your own system requirements.

#### How to use the Nomogram

Example:

What size of pipe will be required for a system 300m long, comprising of fittings with a pressure drop equivalent to a 20m length of pipe. The compressed air is required to drive air tools and equipment with a total air consumption of 200l/s. The minimum pressure required i.e. of the furthest point is 7 bar. A compressor rated at 8 bar and 250l/s has been chosen.

The pipework should be sized for an anticipated future demand of 250l/s.

Therefore:

$$L = 300 + 20 = 320\text{m}$$

$$Q = 250\text{l/s}$$

$$P = 8 \text{ bar}$$

$$\delta \text{ is chosen to be } = 0.1 \text{ bar}$$

The length of the pipework run is plotted on scale 'A' (320m) and flow rate on 'B' (250l/s). A straight line is drawn to connect 'A' to 'B' and extended to 'C'.

The compressor output pressure (8 bar) is now plotted on scale 'E' and the acceptable pressure drop  $\delta$  (0.1 bar) is plotted on 'G'. Again a straight line is drawn to connect 'E' to 'G' which cuts through 'F'.

The intersection points on 'C' and 'F' are now connected with a straight line. The intersection of this line through scale 'D' gives a minimum pipe size. In the example the line 'C' to 'F' cuts 'D' at just under 90mm. 'D' is scaled in standard pipe sizes and therefore the minimum suitable pipe size will be that shown immediately above the intersection i.e. 90mm.

## Pipe sizing

The compressed air mains are the all-important link between the compressor and the point of usage. Correct sizing of the pipework system for both current and future demand is therefore essential to maximise the cost-effectiveness of the system.

Pipework pressure drops are unrecoverable, waste energy and should be kept to an absolute minimum.

Mains which are too small will also cause high air velocity, thus making it difficult to separate the water from the air (since much of the condensed vapour running as water along the bottom of the pipe will be whipped up by, and carried along with, the fast moving air stream).

For the main distribution line from the compressor, excessive pressure drops and energy loss can be avoided by restricting air velocity to a maximum of 6m/s, (1200ft/min). Higher velocities can be permitted in the shorter service lines.

The use of larger pipe sizes is often advantageous, as it can act as a reservoir or receiver for the air thus reducing the load on the compressor and providing capacity for increased future demand.

In order to determine the correct pipe size for a particular length of main, the following information is required.

- Total length of pipework, L(m)
- Volumetric flow rate of air, Q(l/s)
- Pressure output of compressor, P(bar)
- Allowable pressure drop in the system,  $\delta P$ (bar)

Ideally the total system pressure drop should not exceed 0.3 (bar) (BCAS figure). However, a drop slightly in excess of this can usually be tolerated.

## Maximum Recommended flow rates – PN12.5 Durapipe Air-Line Xtra pipe

Applied pressure (bar)	0.5	1	1.5	2	4	6	8	10	12.5
<b>Pipe O/Dia. mm)</b>	<b>Maximum recommended air flow - L/sec (flow velocity &lt; 6m/s)</b>								
16	1.05	1.4	1.75	2.1	3.51	4.91	6.31	7.72	9.47
20	1.76	2.35	2.94	3.53	5.88	8.24	10.59	12.94	15.88
25	2.88	3.85	4.81	5.77	9.62	13.46	17.31	21.16	25.96
32	4.85	6.47	8.09	9.71	16.18	22.65	29.12	35.59	43.68
40	7.61	10.14	12.68	15.21	25.35	35.5	45.64	55.78	68.45
50	11.83	15.77	19.71	23.65	39.42	55.19	70.96	86.73	106.44
63	18.82	25.1	31.37	37.65	62.75	87.85	112.94	138.04	169.42
75	26.74	35.65	44.57	53.48	89.13	124.79	160.44	196.09	240.66
90	38.4	51.2	64	76.8	128.01	179.21	230.41	281.61	345.61
110	57.52	76.69	95.87	115.04	191.74	268.43	345.13	421.82	517.69

Examples of maximum recommended air flow rates for various sizes of Durapipe Air-Line Xtra pipe and air pressures are given in the table above. These are based on a maximum flow velocity of 6 metres per second.

Eg. a compressor delivering 340 litres/sec at 12.5 bar would require a 90mm o/dia Durapipe Air-Line Xtra pipe (actual maximum capacity would be 345.61 litres/sec).

## Pressure drops – fittings

Pressure drop does not only occur in the pipe but also in fittings, valves and filters. Therefore the total is the summation of all the individual pressure drops for valves, filters and other ancillary equipment. For pressure drops across valves, filters and other ancillary equipment refer to the particular manufacturer's literature.

## Pressure drop – Equivalent pipe length in metres

Fitting type	Pipe outside diameter – mm									
	16	20	25	32	40	50	63	75	90	110
90° elbow	1.96	1.26	1.22	1.15	1.11	1.07	1.08	1.09	1.10	1.11
45° elbow	1.26	0.90	0.68	0.46	0.45	0.43	0.40	0.48	0.57	0.69
90° bend	0.85	0.61	0.59	0.49	0.47	0.44	0.42	0.43	0.51	0.59
Tee in line flow	0.87	0.38	0.26	0.29	0.28	0.29	0.23	0.11	0.10	0.15
Tee in line to branch flow	2.45	1.95	1.52	1.44	1.32	1.18	1.06	1.10	1.19	1.32
Reducer	2.04	1.42	1.35	1.29	1.27	1.25	1.28	1.33	1.39	1.45
180° dropper bend	0.36	0.39	0.37	0.36	—	—	—	—	—	—
Composite unions	0.91	0.47	0.41	0.36	0.34	0.31	0.28	—	—	—

## Installation Techniques

Thermoplastics and metals have very different physical and mechanical properties. It is essential therefore that products manufactured from these materials are installed in a manner best suited to the material in question.

Thermoplastic pipes for instance, have a higher thermal expansion rate and greater flexibility than metals. However, by correct supporting and routing the increased flexibility can be used to accommodate any increase in thermal movement.

Installation techniques specific to thermoplastics therefore need to be employed to ensure the efficient operation of the resulting system. Guidelines with respect to Durapipe Air-Line Xtra are detailed in the following pages.

## Pipe supports

### Support Centres

The following support centres are recommended for Durapipe Air-Line Xtra pipes. These should not be exceeded in horizontal lines, otherwise long-term sagging between supports may result. For vertical pipes, the support centres shown can be increased by 50%.

### Durapipe Air-Line Xtra pipe support centres

Outside dia (mm)	Support spacing (m) 20°C	
16	1.1	For each 10°C temperature rise reduce support spacing by 10%
20	1.2	
25	1.4	
32	1.5	
40	1.7	
50	1.9	
63	2.1	
75	2.3	
90	2.5	
110	2.8	

### Support Design

Durapipe Air-Line Xtra pipes are light in weight, (approximately 1/8th the weight of steel), which means that the system supports can be of light construction. If subject to temperature changes, Durapipe Air-Line Xtra will expand more than metal. This expansion should be controlled by laterally constraining the pipes whilst allowing free axial movement.

Thus pipe supports should:

1. Be rigid in construction - To adequately support the pipe (fabricated mild steel angle is ideal).
2. Have a wide bearing area - To allow free transmission of pipe movement and to avoid localised stressing.
3. Be free from sharp burrs or edges - To avoid cutting into the pipe wall.
4. Allow free axial pipe movement - To avoid pipe snaking.
5. Provide lateral restraint - To avoid pipe snaking.

Durapipe Cobra pipe clips should be used with Durapipe Air-Line Xtra. These allow free axial pipe movement and afford lateral restraint.

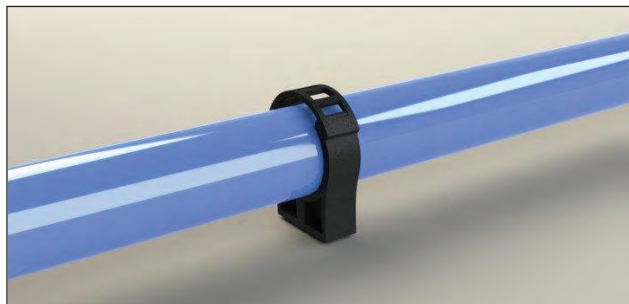

### Support design

The diagrams illustrate the types of support that are ideally suited to the Durapipe Air-Line Xtra system. Support fixings can be via rawlbolts, set pins, lindaptors etc. as appropriate.

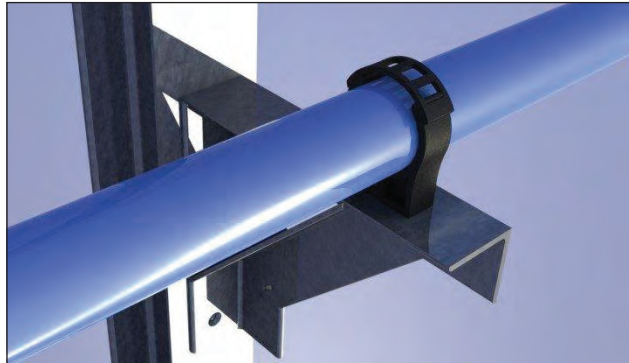
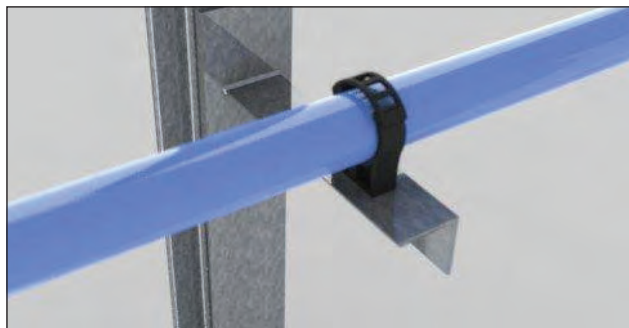

Long hanger rod type supports are not designed to provide lateral restraint to pipework and hence are not recommended for use with Durapipe Air-Line Xtra systems where significant expansion is expected since pipe snaking may result. However, if it is not practical to support by any other method hanger rods can be used with rigid supports. In this case, hanger rods should be kept as short and rigid as possible and also must allow free axial pipe movement.

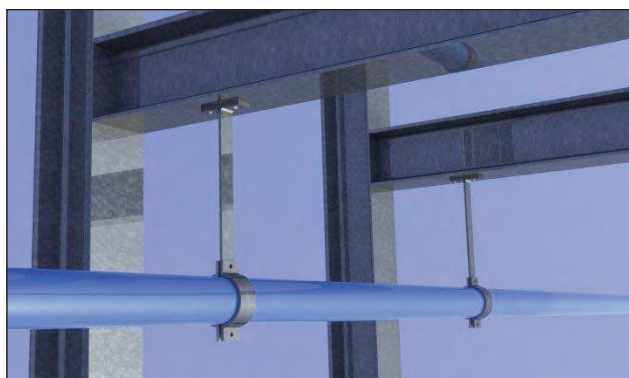

**Support of heavy equipment**

Large valves, filters and other equipment should always be independently supported and anchored to prevent undue loading and stress being transmitted onto the Durapipe Air-Line Xtra system. Valve support plates can be used in place of flange backing rings to satisfy this requirement.

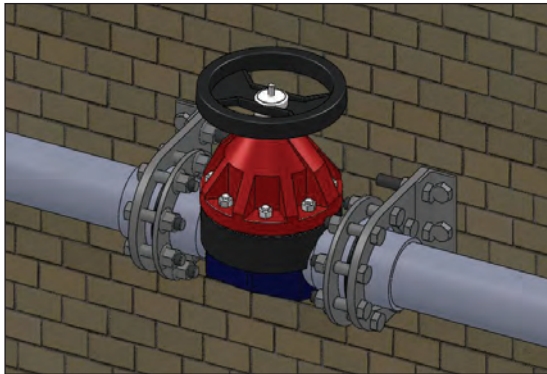

For smaller valves and equipment, two pipe clips situated immediately adjacent to either side of the equipment will prevent transmission of excess torque and other loadings to the Durapipe Air-Line Xtra pipe.



**Thermal expansion**

**Expansion rates**

Whilst thermoplastics expand more than metals, they have a much lower thermal conductivity. This means that the entire wall of a plastic pipe does not reach the same temperature as the contents, unless the pipe is wholly immersed at the same temperature inside and out. The expansion and contraction of a plastic pipe is a function of the change in average temperature of the pipe wall.

This means that the expansion in a thermoplastic pipe is frequently less than expected because the average pipe wall temperature is lower than the contents. Durapipe Air-Line Xtra has a coefficient of expansion of  $10.1 \times 10^{-5}$  per °C compared with  $2 \times 10^{-5}$  and  $1.2 \times 10^{-5}$  for copper and steel respectively.

Approximate expansion rates for Durapipe Air-Line Xtra pipes are shown on the graph at the top of this page. More precise information can be obtained from the formula given on page 14.

**Expansion or contraction of pipe with temperature**

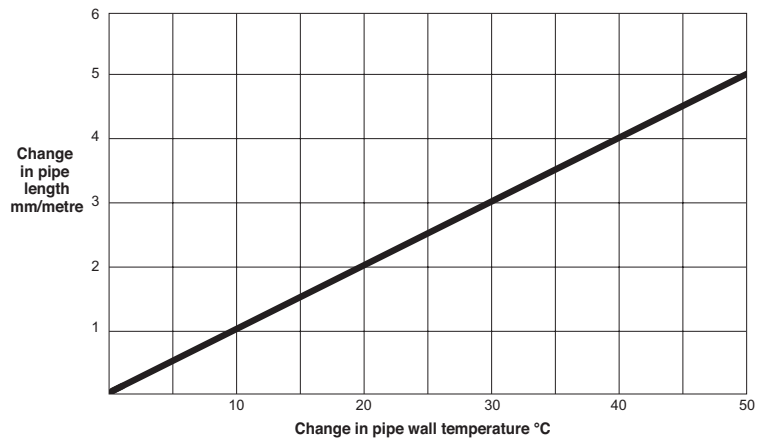

Because of the small differences between ambient and service air temperatures, plus the low thermal conductivity of the Durapipe Air-Line Xtra material, any pipe expansion can usually be accommodated by utilising the natural flexibility of the product and by careful pipe routing.

The basic principle of design is to allow pipe runs to move axially from a fixed point and then to guide this movement into a change of pipe direction ensuring that the pipe is free to flex as shown in Figure 1.

The following examples explain this principle in further detail.

**Pipes constrained at both ends (Fig. 2)**

In the diagram, the pipe run is fixed at one end to the flanged outlet of the air receiver, (Point A), and constrained at the other end by virtue of its close proximity to the wall, (Point B).

As the temperature increases, the pipe will try to expand outwards but will have nowhere to go because of its fixed ends. Thus, the pipe will snake between supports, as indicated.

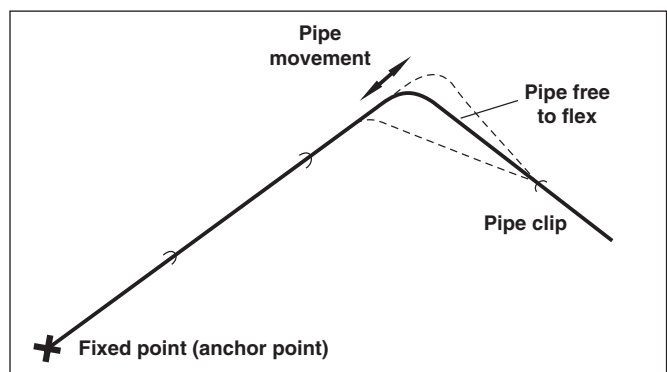

Fig. 1

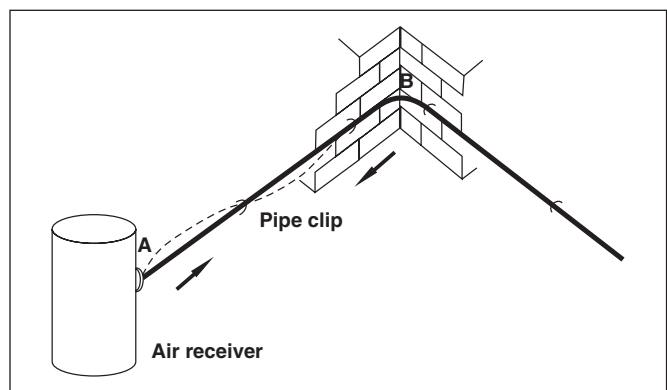

Fig. 2

**Pipes constrained at both ends –  
 Solution (Fig. 3)**

By utilising fabricated angle iron brackets and Cobra pipe clips along pipe length, B to D, the pipe can be installed away from the wall with sufficient room for the pipe to expand and contract.

Now the pipe will expand away from its fixed point, (the air receiver – A), and the movement will be guided into the change of direction, ie. pipe leg length B to D.

**Note:** The support at C remains but the clip is removed to give sufficient leg length for flexibility.

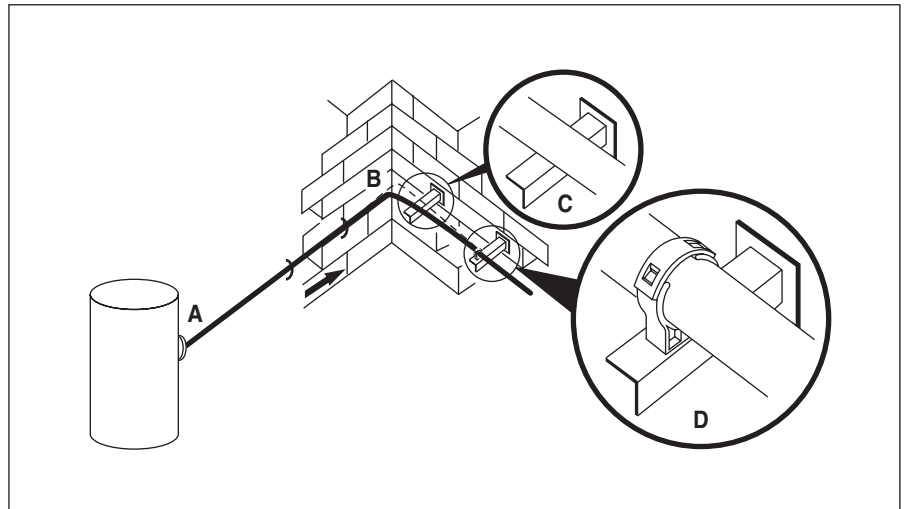

Fig. 3

**Pipe anchors (Fig. 4)**

In the previous example, the air receiver acted as an anchor point to the pipe system and this served to direct the thermal expansion of the pipe – ie. the pipe was forced to move in one direction from Point A.

Equipment such as valves, filters and lubricators may need independently supporting, as previously indicated (pages 11-12). These supports will automatically serve as anchors to the system.

Where natural anchors do not exist pipe movement should be controlled by constructing anchor points.

Typical methods are shown in Figs 5 and 6. It should be noted that under no circumstances must the pipe be physically gripped or compressed – simply restrained from moving.

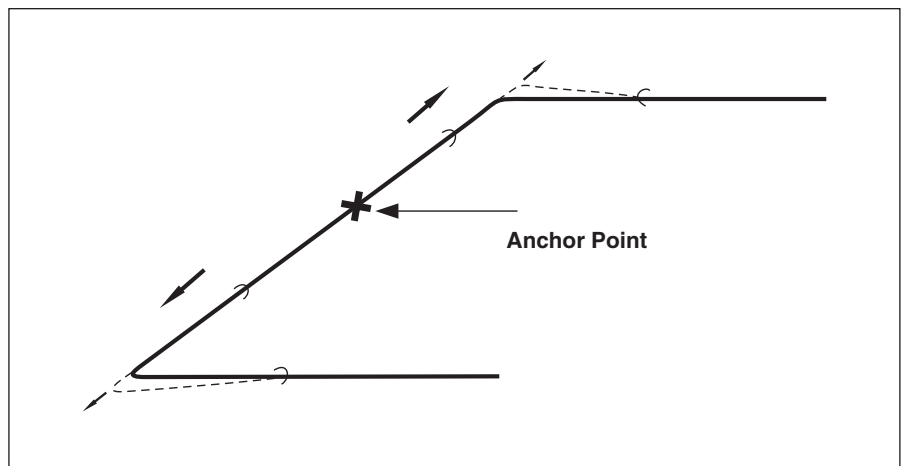

Fig. 4

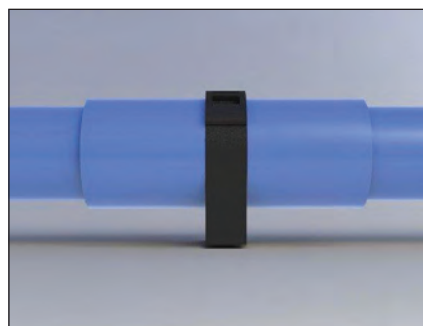

Fig. 5

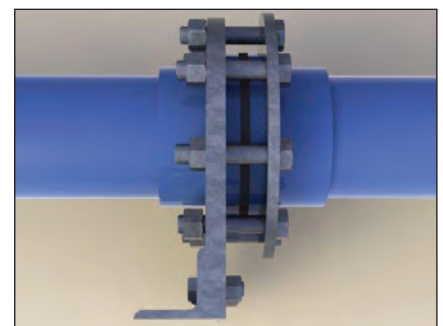

Fig. 6

**Pipe flexibility**

It is essential that the pipe leg (H in Fig. 7) into which expansion is being directed is flexible enough to accommodate the expected movement. In certain cases leg lengths may need to be increased. Where insufficient flexibility exists then expansion loops may be required (see Fig. 8).

Figure 9 illustrates these principles in system layout. The pipe (A) will be liable to excessive force generation since no allowance for movement is made. However in the case of pipe (B) the pipe loop allows for the take-up of movement.

Independent of the type of supports, all support surfaces offer frictional resistance to the movement of pipe. This resistance is cumulative and in order to prevent it exceeding the buckling load of the pipe, provision for expansion should be incorporated at intervals not exceeding 40m.

The degree of flexibility required in pipe legs is dependent upon the amount of pipe expansion to be accommodated. Typical calculations are detailed on page 16.

**Flexibility – sizing of leg lengths and loops**

The actual expansion or contraction of Durapipe Air-Line Xtra pipe is dependent on the change in temperature of the mid-wall of the pipe. The mid-wall temperature is dependent on the internal and external environmental temperature with the temperature of the flowing media having the greater influence, unless the pipework is subjected to radiated heat.

The actual mid-wall temperature can be difficult to determine. Expansion and contraction is therefore calculated using the installation temperature and maximum and minimum system temperatures.

The greatest temperature difference ( $\Delta T$ ) between the installation temperature and the extremes of system temperature should be used in the following equation to calculate the maximum thermal movement.

$$\Delta L = L \alpha \Delta T$$

- Where:
- $\Delta L$  = Change in length of pipework section under consideration in metres
  - L = Original length of pipe in metres
  - $\alpha$  = Coefficient of linear expansion of pipe material in  $m/m^{\circ}C$
  - $\Delta T$  = change in pipe temperature

For Air-Line Xtra  $\alpha = 10.1 \times 10^{-5}$  per $^{\circ}C$

The resulting value of expansion can then be entered onto the graph opposite and the appropriate leg length, or loop size, read directly from the graph.

**Configurations to accommodate expansion**

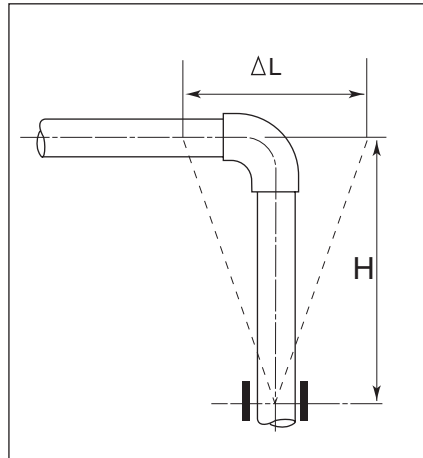

Fig. 7

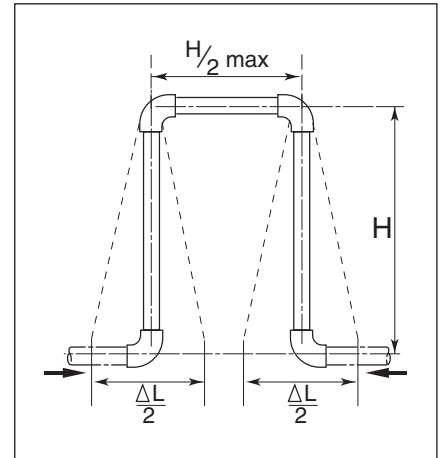

Fig. 8

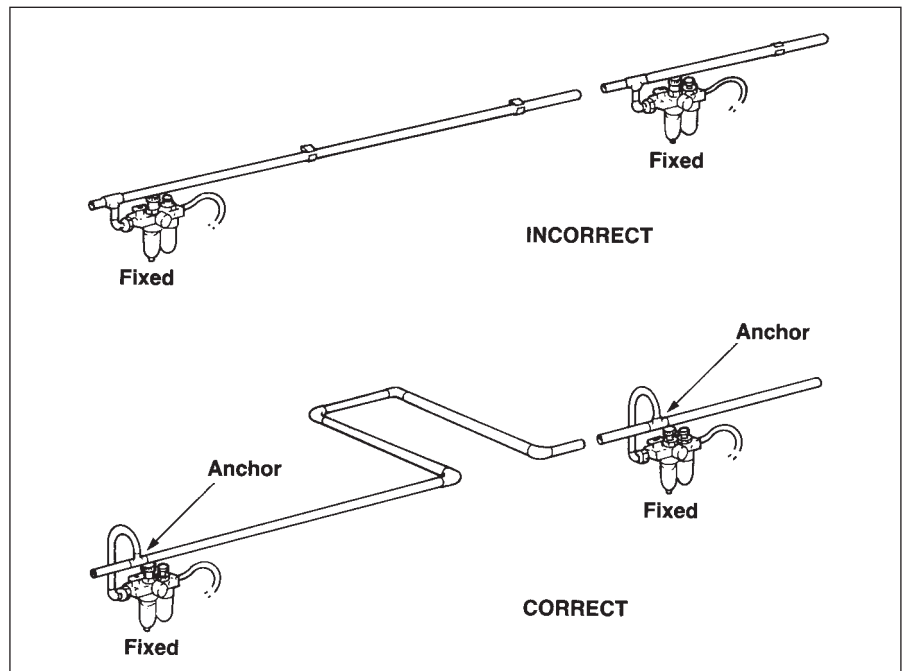
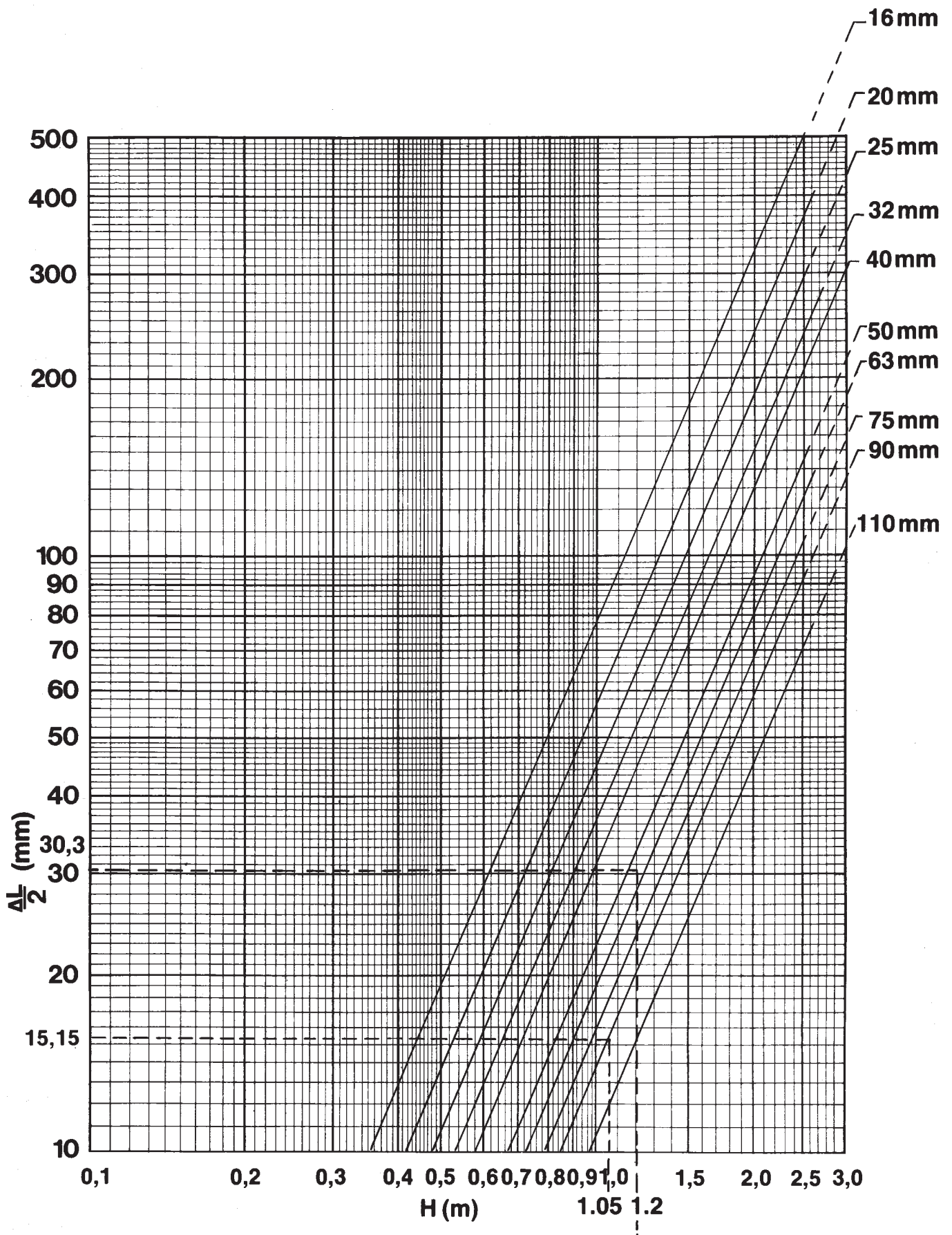

Fig. 9



### Example 1: Leg length

The 90mm Durapipe Air-Line Xtra pipe shown in (Fig. 10) is conveying the compressed air at a temperature varying between 20°C and 40°C. The installation temperature is 25°C. Determine the free leg length required at the change of direction to accommodate thermal expansion.

#### Solution:

$$\Delta T_1 = (40-25) = 15^\circ\text{C expansion}$$

AND

$$\Delta T_2 = (25-20) = 5^\circ\text{C contraction}$$

Using the greater value  $\Delta T_1$ , the pipe expansion can be calculated.

$$\Delta L = L \alpha \Delta T_1$$

$$\therefore \Delta L = (10 \times 10^3) (10.1 \times 10^{-5}) (15)$$

ie.  $\Delta L = 15.15\text{mm}$

#### Calculate leg length A-B

Using the value of 15.15mm draw a horizontal line on the graph (page 15) from the vertical scale to meet the 90mm pipe gradient line. Drop a perpendicular from the intersection point, to the horizontal scale. The figure obtained is the leg length required, ie. length A to B.

In this case therefore, the leg length will be 1.05 metres, ie. the first support guide should be positioned at B, 1.05 metres from the elbow at A.

**Note:** A support without a guide will be required at point A.

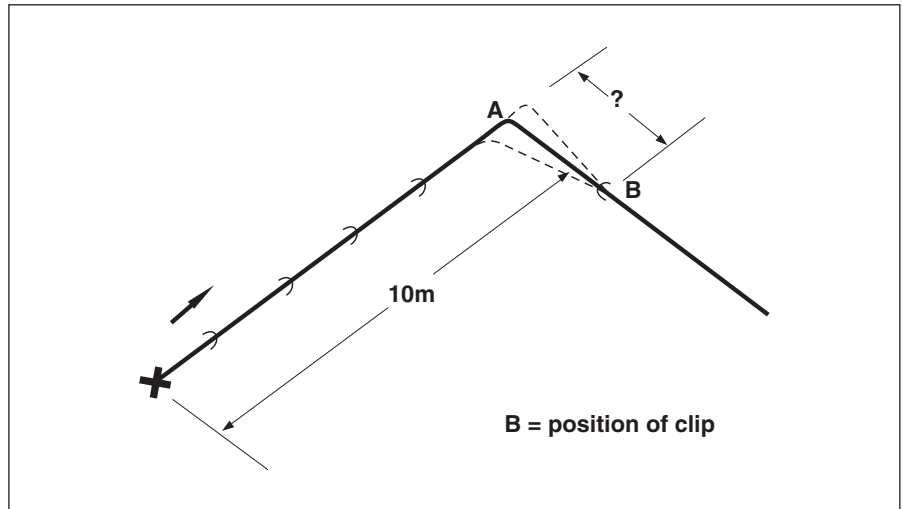

Fig. 10

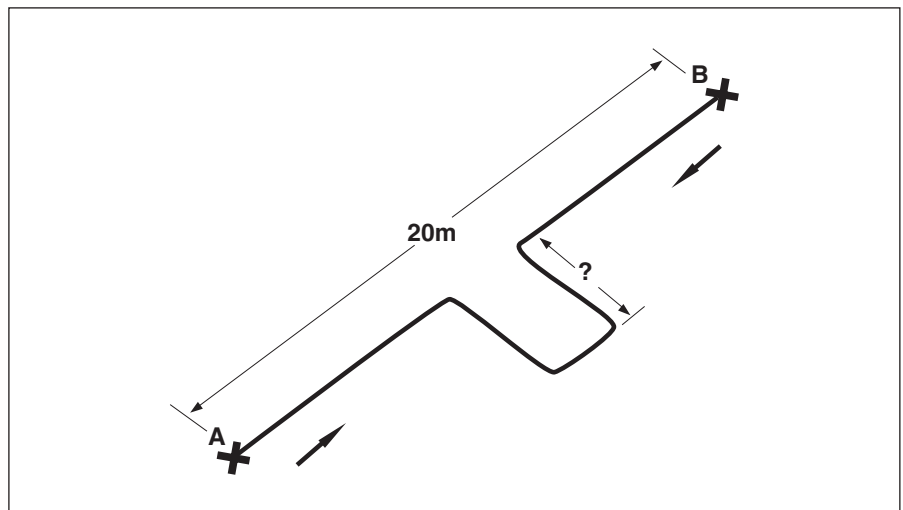

Fig. 11

### Example 2: Expansion loops

Determine the loop size required in a 63mm Durapipe Air-Line Xtra pipe which is constrained at both ends as shown in (Fig. 11). The compressed air temperature varies between 5°C and 50°C. The installation temperature is 20°C, but in the winter shut down period the temperature can drop to 0°C.

The solution follows exactly the same principles followed in the previous example.

$$\Delta T = (50-20) = 30^\circ\text{C expansion}$$

AND

$$\Delta T = (20-0) = 20^\circ\text{C contraction}$$

$$\Delta L = L \alpha \Delta T$$

$$\therefore \Delta L = (20 \times 10^3) (10.1 \times 10^{-5}) (30)$$

ie.  $\Delta L = 60.6\text{mm}$

#### Calculate loop size

In this case the expansion is equally split and is directed inwards from points A and B. Therefore, using a value of  $\Delta L/2$  (ie. 30.3mm) draw a horizontal line on the graph from the vertical scale to meet the 63mm pipe gradient line. Drop a perpendicular from the intersection point to the horizontal scale. The figure obtained is the leg length of loop offset required, ie. 1.2mm.

#### Key to Figures 10-11

- X** Fixed point
- Direction of expansion
- - -** Pipe movement



## Buried pipes

Durapipe Air-Line Xtra is equally suited to above ground and buried use. Recommendations covering essential requirements for large runs below ground may be summarised as follows:

In general, trenches should not be less than 1 metre deep. However, site conditions may permit pipes being laid nearer the surface and the Technical Support Department should be contacted for detailed advice.

Trenches should be straight sided and as narrow as practicable to allow proper consolidation of packing materials. Trench bottoms should be as level as practical. Large pieces of rock, debris and sharp objects should be removed.

Unless the excavation is in ground of friable, small and regular material, a bed of finely graded gravel should be laid (9mm or similar) approximately 75mm deep on floor of trench. (Sand may be used but a high water table may wash sand away and leave the pipe unsupported.)

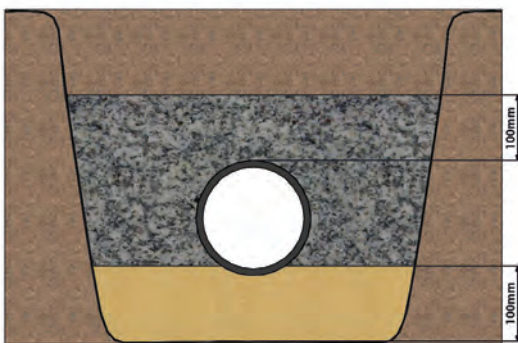

If pipes are jointed above ground, they should remain undisturbed for 2 hours before being 'snaked' into the trench. Alternatively, they may be jointed in the trench.

Particular care should be taken to ensure that pipes and jointing materials are thoroughly dry and that the jointing procedure shown on pages 18-19 are strictly followed.

After laying, pipes should be covered with pea gravel, or similar material, to a depth of 75mm above the pipes and extended sideways to both trench walls. Joints should be left exposed for pressure testing.

Care should be taken to ensure that sharp objects, stones etc., are prevented from falling into the trench before covering the pipe with pea gravel.

Back filling should be carried out between joints and consolidated prior to pressure testing.

After pressure testing, joints should be covered with pea gravel and back filling completed.

Because of the water vapour which can build in any compressed air system, drain pits should be constructed at the lowest points of the line in order that a drain facility can be incorporated.

## Testing

It is suggested that the following test procedure be followed, after joints have been allowed to dry for the appropriate minimum time.

The system should be divided conveniently into test sections. Fill the section with cold water making sure that no air pockets remain. Do not pressurise at this stage.

Check the system for leaks. If no leaks are apparent check for and remove any remaining air. Increase pressure up to 50lbf/in<sup>2</sup> or 3 bar. Do not pressurise further at this stage.

Leave the section pressurised for 10 minutes. If the pressure decays, inspect for leaks and rectify as necessary. If the pressure remains constant, slowly increase the hydrostatic pressure to 1<sup>1</sup>/<sub>2</sub> times the nominal operating pressure.

Leave the section pressurised for a period not exceeding 1 hour. During this time the pressure should not change.

## Installation Guide

Joining of Durapipe Air-Line Xtra pipes and fittings is achieved by means of the cold solvent welding process. Correctly made, the resulting joints are stronger than either pipe or fitting. Solvent cement welding offers a fast and simple means of constructing leak-free, high intensity pipe joints.

The Durapipe Air-Line Xtra solvent cement is designed and formulated to match the performance of the system. When applied, it will chemically soften the prepared surfaces of pipe and fitting, thus allowing fusion between the mating surfaces to create a homogenous joint when brought together.

Correct, high integrity jointing is dependent upon the removal of all traces of foreign matter from the mating surfaces ie. oil, dirt grease etc. The cleaner the mating surfaces prior to jointing, the stronger the resulting joint will be.

**The following jointing procedure must be used to achieve maximum joint efficiency.**



1. Equipment required.



2. Cut pipe to required length.



3. Chamfer end of pipe using a chamfering tool or file.



4. Abrade pipe and fitting.



5. Measure socket depth.



6. Mark on pipe socket depth and a known value.



7. Clean pipe and fitting with eco cleaner.



8. Stir solvent cement.



9. Apply cement to pipe and fitting.



10. Push fitting home and hold for a few seconds.



11. Cement will form a neat-bead. Wipe off excess cement with a lint-free cloth.

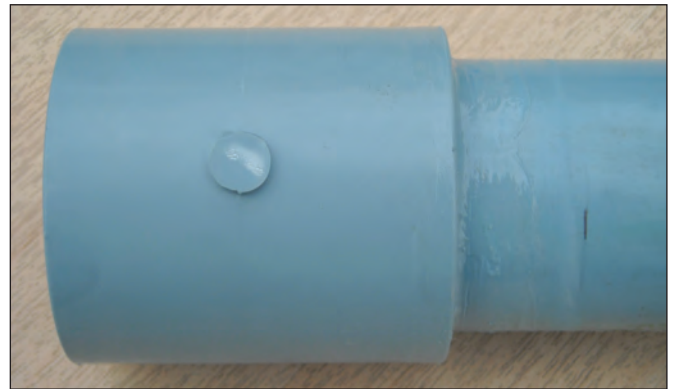

12. Using the previously marked guide, check the pipe is fully inserted into the fitting.

### Precautions

- Always use clean, lint free cloth or industrial wipes.
- Always use genuine Durapipe Air-Line Xtra solvent cement and eco cleaner.
- Always replace lids on containers after use.
- Always keep joint surfaces dry.
- Never use cement or cleaners in confined spaces without adequate ventilation.
- Never joint near naked flames.
- Do not smoke in the working area.
- Never dilute cement with eco cleaner.
- Solvent cement and cleaners are hazardous, flammable materials and should be stored and handled with care and kept out of the reach of children.
- Safety Data Sheets for these products are available.

### Number of joints per litre

Under normal conditions the following approximate number of joints can be made per litre of solvent cement. Actual usage will depend upon ambient conditions and fit between pipe and fitting.

- 16-40mm : 400 joints
- 50-63mm : 110 joints
- 75-90mm : 40 joints
- 110mm : 25 joints

### Setting Times

Surrounding temperature	Up to 63mm		75mm-110mm	
	Up to 6 bar	Up to 12.5 bar	Up to 6 bar	Up to 12.5 bar
10°C - 30°C	2 hours	4 hours	4 hours	12 hours
5°C - 10°C	4 hours	6 hours	6 hours	24 hours

## Jointing Methods

### Miscellaneous jointing

#### Threaded connections - Durapipe Air-Line Xtra to metal

Connections to metal threads can be readily made using female threaded adaptors, plain/threaded sockets, or composite unions. Durapipe Air-Line Xtra pipes must not be threaded.

PTFE tape wound onto the male thread will effect a good seal between plastic and metal threads (Fig. A).



Fig. A

**Anaerobic adhesive thread sealants (eg. Loctite, 542, 572 and some other types of sealant pastes) can chemically attack Durapipe Air-Line Xtra and must not be used. Confirmation of suitability can be obtained from Durapipe UK Technical Support.**

Care should be taken not to overtighten connections. Durapipe Air-Line Xtra threaded fittings should be restrained from twisting during assembly using wrenches if necessary. Stillsons, or similar wrenches must not be used around Durapipe Air-Line Xtra pipes. Durapipe Air-Line Xtra should not be connected directly to vibrating machinery. Flexible rubber couplings or rubber hoses should be incorporated to absorb any movement.

### Connections to Instrumentation

Pressure gauges, temperature gauges and flow measurement (Fig. B), probes can be connected into the Durapipe Air-Line Xtra system via female threaded adaptors or composite unions solvent welded into plain Durapipe Air-Line Xtra tees. Heavy items should be independently supported.



Fig. B

### Quick release coupling connections

#### High level

Quick release couplings or hoses may be connected into the Durapipe Air-Line Xtra system at high level (ie. at positions not normally accessible from floor level and not subject to frequent connection and disconnection or dynamic forces) by means of a female threaded adaptor or composite union solvent welded onto a dropper bend. In this particular case it is recommended that the connection should be reinforced using two pipe clips, as illustrated (Fig. C).



Fig. C

### Termination of drop legs

It is important that the lower end of all pipe droppers and any take-off points, particularly those employing flexible hoses, are rigidly attached to walls, stanchions etc. Two methods are available for such terminations:

Durapipe Air-Line wall brackets offer this facility and must be used at the lower end of vertical droppers to prevent strain from flexible hoses, when drains are not required.

If drains are to be fitted such that the take-off from the dropper is via a tee piece, then the wall bracket is connected via the branch line as shown below (Fig. D).



Fig. D

### Demountable joints

Systems which are required to have a demountable facility can be effected by using Durapipe Air-Line Xtra socket unions or stub flanges. These can also be used at fixed terminal connections such as air receivers or dryers (Fig. E).

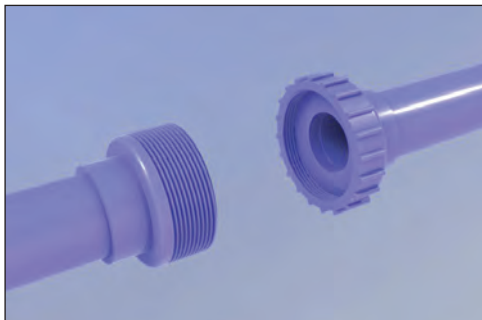

Fig. E

### The use of bushes, reducers and threaded adaptors

#### Reducing bushes

Reducing bushes offer a neat and simple method of reducing socket size in the minimum of space.

Care must be taken to properly prepare all jointing surfaces as recommended earlier, with the end of the bush being chamfered (unless a moulded chamfer is included).

#### Example in the use of reducing bushes

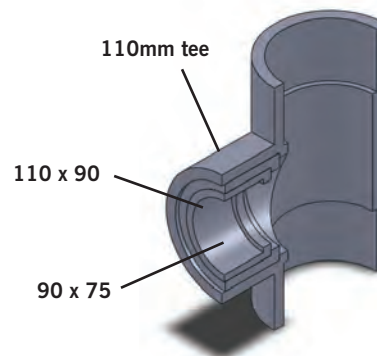

#### The use of reducers

All fittings have female ends, dimensionally controlled for cold fusion jointing. In addition, reducing sockets in the Metric series have controlled outside diameter at the larger end. This allows use as a male or female component, as illustrated.

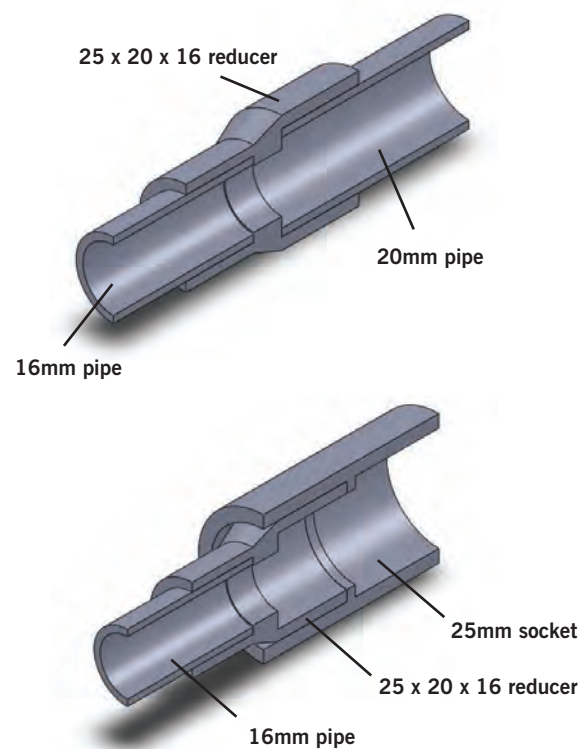

#### The use of Metric series threaded adaptors

Female and male threaded adaptors have controlled inside and outside diameters on the plain end and can therefore be used as either a male or female component.

## Safety Precautions

### Areas to use

**Durapipe Air-Line Xtra must be used downstream from the receiver or aftercooler only.**



Care must be taken to avoid overheating Durapipe Air-Line Xtra. Metal pipes must be used between compressor and receiver and at any other part of a system where conditions exceed those permissible for Durapipe Air-Line Xtra. Refer to page 8.

### Installation precautions

Lubricators must only be installed at the downstream extremities of the system.

Durapipe Air-Line Xtra pipes must not be bent. Standard elbows and moulded bends are available throughout the size range. Certain types of flexible hose contain plasticisers which may be harmful to Durapipe Air-Line Xtra pipe. Therefore, the suitability of hoses which are to be installed up-stream of the Durapipe Air-Line Xtra system must be checked with our Technical Support Department prior to installation.

If thermal insulation is required, the suitability of the materials used and any associated adhesives must be confirmed with our Technical Support Department prior to installation. Purge new compressors and ancillary equipment including new steel pipework prior to connecting to Durapipe Air-Line Xtra pipework.

### Inspection and testing

After installation, the Durapipe Air-Line Xtra system must be inspected for external damage in the form of cuts or deep notches. Any such damaged areas must be cut out and replaced. The normal precautions for testing a compressed air system before pressurising must be followed for the Durapipe Air-Line Xtra system.

### UV light

Care should be taken to avoid prolonged exposure to sunlight, which will cause discolouration of the Air-Line Xtra material. If stored outdoors, products must be underneath an opaque covering, eg. a tarpaulin. If installed in a location exposed to sunlight, the pipework should be painted.

### Health and Safety at Work Act & COSHH Regulations

Attention is drawn to the requirements in the UK of this Act and to the 1988 Control of Substances Hazardous to Health (COSHH) Regulations.

Durapipe UK cannot accept responsibility for accidents arising from the misuse of its products because of bad installation or incorrect application.

## General Information

### Handling and Storage

Durapipe Air-Line Xtra systems provides some protection against damage but care should be taken at all stages of handling, transportation and storage. Pipe must be transported by a suitable vehicle and properly loaded and unloaded, eg. wherever possible moved by hand or mechanical lifting equipment. It must not be dragged across the ground. The storage should be flat, level and free from sharp stones.

### Lengths

Pipe lengths stored individually should be stacked in a pyramid not more than one metre high, with the bottom layer fully restrained by wedges. Where possible, the bottom layer of pipes should be laid on timber battens at one metre centres. On site, pipes may be laid out individually in strings. (Where appropriate, protective barriers should be placed with adequate warning signs and lamps.)

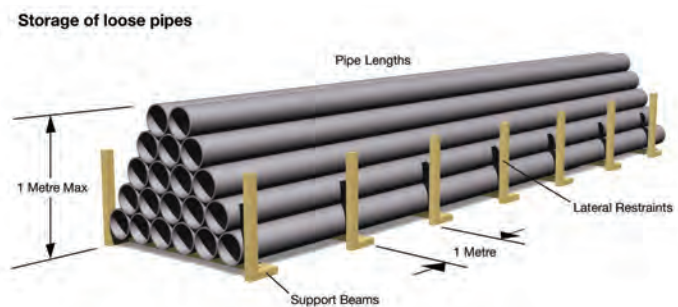

### Bundles

Bundled packs of pipe should be stored on clear, level ground with the battens supported from the outside by timbers or concrete blocks. For safety, bundled packs should not be stacked more than three metres high.

Smaller pipes may be nested inside larger pipes. Side bracing should be provided to prevent stack collapse. Similar precautions should be taken with fittings and these should be kept in protective wrappings until required for use.

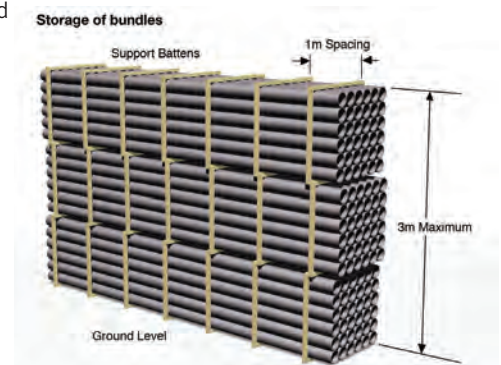

### Weathering

If prolonged storage (greater than 1 month), or storage in areas where high temperature is anticipated, the stack height should never exceed 4 layers or 1 metre maximum height. Such stacks should be protected from the effects of weathering (particularly ultraviolet exposure) by placing an opaque covering over them. If fixed to the side bracing the sheets will provide protected and shaded conditions. It will also allow a free passage of air around the pipes.

### Compressor oils

Synthetic oils must not be used with Durapipe Air-Line Xtra. A few additive rich mineral oils used for compressor lubrication are also incompatible with Durapipe Air-Line Xtra pipework and harmful effects may result in the event of any oil being carried over into the pipework system. A degree of protection can be achieved by installing oil separators upstream of the Durapipe Air-Line Xtra system; but technical research has shown that even with this safeguard most synthetic oils and certain mineral oils should not be used in conjunction with Durapipe Air-Line Xtra. As a safeguard therefore, compressor oil suitability must be checked with our Technical Support Department prior to installation.

## Compressor Oil Suitability

Oils known to be suitable for use in conjunction with Durapipe Air-Line Xtra pipework are as follows. This list must be used in conjunction with compressor manufacturer's recommendations.

IT IS IMPORTANT THAT FULL DESIGNATION OF OIL IS KNOWN. EG. ESSO TERESSO 46 IS NOT THE SAME AS ESSO TERESSO EP 46.

### AGIP

OSO 32, 46, 68, 100  
Dicrea 68, 100, 150  
Acer 46, 68, 100  
OTE 46, 68, 80, 100  
Motor Oil HD 10W/20, 20W/30, 40  
Diesel Sigma S 10W, 20W/20, 30, 40

### AMOCO

ATF Multi-purpose Compressor Oil 260

### AMSOIL

Reciprocating Compressor Oil

### ARAL

Vitam GF (all viscosities)  
Kowal M (all viscosities)  
Kosmol TL (all viscosities)  
Motanol GM 68  
Motanol HE (all viscosities)  
Motanol HK (all viscosities)  
Motanol HP (all viscosities)  
Vitam DE  
Vitam HF (all viscosities)

### ATLANTIC RICHFIELD

Duro 10, 22, 32, 46, 68, 100  
Polar 58  
Gascon 58  
Rubilene 68

### ATLAS COPCO

Roto inject fluid  
Polyalphaolefine Oil

### AVIA

Avilube VD-L 100, 150  
Motor Oil HD 30  
Motor Oil SAE 30

### BATOYLE

Typhon HDT 32, 68, 100  
Renown K 40  
Apollo 32

### BELRAY

SCI 46

### BRENNTAG

Kompressorenol VC-L 68

### BRETTS

Ovoline 660 HD 30  
Ovoline 9032, 9068, 2032, 2068

### BRITISH PETROLEUM

Energol RC-R 32  
Energol THB 32, 46, 68, 77, 100  
Energol HLP 32, 46, 68, 100  
Venellus M 10W, 20W, 30, 40  
Energol IC-D 40  
Energol HP 150  
Energol RC 32, 68, 100  
Vanellus T 40  
Energol SHF 32, 46, 68, 100

### BROOMWADE

4000 Hour

### CASTROL

Aircol PD 32, 68, 100, 150  
Hyspin AWS 22, 32, 46, 68, 100  
Deusol CRI 10, 20, 30, 40  
Agricastrol 10, 20, 30, 40, 50  
Andarin 32, 42, 46  
Perfecto T 32, 46, 68, 100  
Product 672/49  
Magna 32

### CENTURY

ACA  
ACC  
ACD  
ACE  
PWLC  
Turbo 10W  
Compressor Oil B  
Special Medium  
Turbine Oil  
Centlube Supreme 20W/20  
Centraulic AF 68

### CHEMODEX

Zephyr HT 68  
CHEVRON  
OC Turbine Oil, 32, 46, 68, 100, 150  
EP Industrial 46, 68, 100  
EP Hydraulic Oil 22, 32, 46, 68, 32 HV, 68 HV  
Delo 200E Motor Oil 10W, 20W/20, 20W/30, 30, 40  
Delo 100, 10W, 30, 40  
Tegra 68  
Tegra FLC 32, 100  
Tegra FLD C 32, 68, 100  
GP Oil 100

### COFRAN

Turbicof  
Cofraline

### CONDAT

Aeropress 32, 46, 68, 100, 150, 320  
Hydrolub ZS 32, 46, 68  
Vicom Special 10W, 20, 30, 40  
Aerospace S100  
Vaseline 2442

### CONOCO

American Industrial 100  
Iso. Vis. Compressor 100  
Super Hydraulic 5W/20 22, 32, 46, 68, 100  
Dectol R & O (all viscosities)  
Turbine 32, 46, 68, 100

### CORROLESS

Anderol R2214

### CPI ENGINEERING SERVICES

CP 4600 32F, 68F  
Comp. Oil 68  
Aeon 4000  
CP4608 68F  
CP9001 32

### DENTON

Compol 30

### DEVILBISS (FRANCE)

Compoil

### DUBOIS

Ultragard 200  
MPO 20

### DUCKHAMS

Deenol 20, 30  
Zodiac 4, 6

### ECUBSOL

KYM  
TWL  
TWM  
Turbo 32

### ELF

Dacnis P 32, 68, 100  
Series 3 Engine Oil  
Sportigrade 15W/30  
Barelf 100  
Olina 32

### EMERY

2819 B  
3006

### ESSO

Tereso 32, 46, 68, 77, 100, 150, 220, 320, 460  
Nuto H 22, 32, 46, 68, 100  
Extra Motor Oil 10W/30, 20W/50  
Plus Motor Oil 10W, 20W/20, 30, 40  
Uniform 15W/30  
Zerice S 68, 100  
Uniflow 15W/50, 10W/40  
Superlube 10W/40  
Verdichteroel 3020, 3021N, 3022N  
Spinesso 22  
Essolube HDX Plus 10W, 20W/20, 30, 20W/30, 40  
Primol 325  
HLPD 32  
Super Oil 15W/40  
Tereso L-100

### EXXON

Primol 185, 205, 325, 355  
Teresstic 32, 33, 46, 68, 77, 100  
Esstic 32, 68, 150

### FANAL

Salvo VD-L 68, 100, 150

### FILMITE

Filmite 150

#### **FINA**

Bakola (all viscosities)  
Hydran (all viscosities)  
Circan (all viscosities)  
Solco (all viscosities)  
Delta Plus (all viscosities)  
Eolan AC (all viscosities)  
Eolan DCL (all viscosities)

#### **FREEDOM**

Compressor Oil 32, 68  
Hydraulic Oil H27  
Lubace HD 10W

#### **FUCHS**

Renolin B (all viscosities)  
Renolin DTA (all viscosities)  
Renolin 104L  
Renolin MR (all viscosities)  
Renolin 504  
Renolin SC 46  
Renolin SC 46MC  
Renolin 104  
Renolin 102L  
Renolin 106L  
Renolin DT2  
Ratak MN202  
Durapipe Air-Line Xtra system users guide

#### **GULF**

Harmony AW (all viscosities)  
Compressor Oil 32, 68, 100  
Hydrasil (all viscosities)  
SD 30  
Senate 320-D  
Senate 400-D  
Senate 375  
Senate 680  
Senate 460  
Harmony 22

#### **HYDROVANE**

2000 Compressor Oil

#### **INGERSOLL RAND**

Food Grade

#### **JUN-AIR**

NMI-50

#### **KERNITE**

Lubra-K-CO  
Lubra-K-RT  
Lubra-K-MPC

#### **KUWAIT PETROLEUM**

Q8 Verdi 320

#### **LUBRICATION ENGINEERS**

Monolec GFS

#### **MARGOLIS**

Silogram MP 157  
Silogram MP 207  
Silogram MP 307  
Silogram MP 507  
Silogram MP 707

#### **MIHAG**

HS32  
CD46  
CA68

#### **MOBIL**

Vacuoline 128  
DTE Light  
DTE Medium  
DTE Heavy Medium  
DTE Heavy  
DTE 22, 24, 25, 26  
Rarus 424, 425, 427, 725  
Delvac 1240, 1310, 1110  
HD Oil 100  
ED 62/170  
Almo 527  
Arctic SHC 234  
DTE Extra Heavy  
DTE 13  
DTE 105  
Velocite 6, 10  
ATF Multi-purpose  
Rarus 725  
Mobiland Universal  
DTE 103  
Multigrade 15W/40

#### **MOLUB-ALLOY**

General Purpose 40

#### **MOTUL**

CFS-100  
DSM-40  
Safco D

#### **NEEDWOOD**

Imperial CDX 10, 10W/30

#### **OMEGA**

Omega 631

#### **OPTIMOL**

Kompressorenol VD-L 100  
Super HD-30

#### **PETRO-CANADA**

Super Compressor Oil 32, 68, 100, 150  
Purity FG 32, 46, 68, 100

#### **SCHAEFFERS**

NO. 158 10W, 20W, 30W, 40W

#### **SENTINEL LUBRICANTS**

SCO 10, 20, 30, 40

#### **SERVO-DELLEN (NUODEX)**

Anderol FGC-20  
Anderol RCF-P 46

#### **SHELL**

Tellus 22, 32, 37, 46, 68, 100  
Corena H 68, 100, 150  
Corena 37  
Tellus T 15, 22, 37, 46, 68, 100  
Tellus S, 32, 37, 46, 68  
Tellus C 32, 68, 100  
Tellus R 37, 46, 68  
Turbo T 32, 46, 68, 100  
Rotella X 20W/40, 10W, 20/20W, 30, 40  
Rimula X 10W, 30, 40, 50, 15W/40  
Rimula 10W, 20/20W, 30, 40, 50  
Talpa 20W, 20, 30, 40, 50, 60  
Comptella 46  
Corena S46  
Talpa G 100  
Corena P 68, 100, 150  
Comptella S46

#### **SILKOLENE**

Derwent 32, 46, 68  
Trent 32  
Silkair VG22  
Dove 68

#### **SMALLMAN**

Crownlube A16

#### **STATOIL**

Compway 32, 46, 68, 100

#### **SULLAIR**

LLL-4  
24KT  
SRF 1/4000

#### **SUMMIT**

FG-200  
FG-300

#### **TEXACO**

Rando 32, 46, 68, 150  
Rando HD 32, 46, 68  
Ursa P 32, 68, 100, 150, 200, 220  
Ursatex 10W, 20W/20, 30, 40  
Compressor Oil VD-L 46, 100, 150  
Compressor Oil VW 460  
Regal R-O 32, 46, 68, 100, 150  
Havoline All Temp. 15W/40  
Texamatic 9226  
Auriga EP46  
Havoline Motor Oil 15W/40  
Rando HD Z 32  
Capella WF 22, 100  
Cepheus 68  
Sera 5

#### **TOTAL**

Cortusa 32, 68, 100, 150  
Azolla 10, 22, 32, 46, 68, 100  
Cortis EP 46, 100, 150  
HD3C 10W  
Rubia H 10W  
Preslia 46

#### **ULTRACHEM**

Chemlube 530

#### **UNOCAL**

Guardol 15W-40

#### **VALVOLINE**

ETC 30  
Turbinenol 2S, 3S  
ETC Light  
Ultramax 32  
Motor Oil 30W

#### **WINTERSHALL**

Wiolan WT 46

#### **WITCO**

RDN 654  
RDN 130  
RDN 130R

#### **ZELLER & GMELLIN**

Divinol Spezial 2000 HD 30  
Kompressorenol ZET-GE

Should you have any queries regarding compressor oils please contact our Technical Support Department.



## Index to Air-Line Xtra Imperial Fittings

**Note:** Two-dimensional Auto-CAD drawings are available on [www.durapipe.co.uk](http://www.durapipe.co.uk)

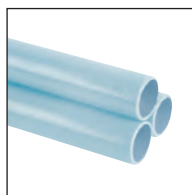

Pipe (plain)  
page 26

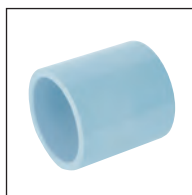

Sockets  
page 26



Reducing bushes  
page 26



Reducers  
page 27



Elbows 45°  
page 27



Elbows 90°  
page 27



Bends 90°  
page 27

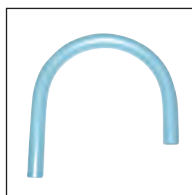

Dropper bends 180°  
page 28



Tees 90° equal  
page 28



Tees 90° reducing  
page 28



End caps  
page 28

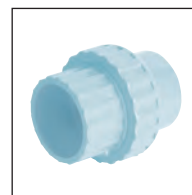

Socket unions  
page 29

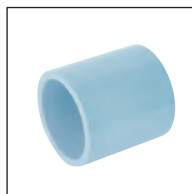

Plain/Threaded sockets  
page 29



Female threaded  
adaptors  
page 29

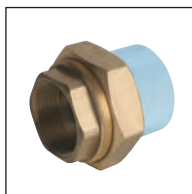

Female composite  
unions  
page 29

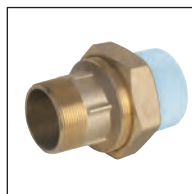

Male composite unions  
page 30



Wall brackets  
page 30



Wall brackets -  
Multiport  
page 30

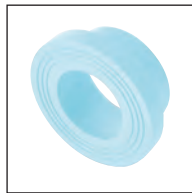

Flanges stub  
page 30



Flanges blanking  
page 31



Backing rings  
page 31

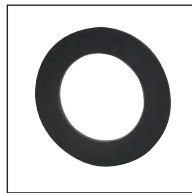

Gaskets flat  
page 31



Flange assembly kits  
page 31



Valve support plates  
page 31

## Valves



VKD Double union  
ball valves  
page 32



FK Butterfly valves  
page 32



VM Diaphragm valves  
page 32

## Accessories



Cobra pipe clips  
page 33



Air-Line Xtra solvent  
cement  
page 33



Eco cleaner  
page 33



Chamfering and  
de-burring tools  
page 33



Pipe cutters  
page 33

## Pipe PN12.5

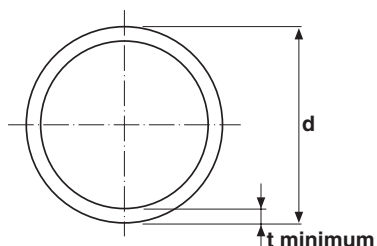

Size $d_1$	t	kg/m	SL	Code
16	1.9	0.10	5	31 557 305
20	2.1	0.13	5	31 557 306
25	2.4	0.18	5	31 557 307
32	2.9	0.28	5	31 557 308
40	3.6	0.46	5	31 557 309
50	4.5	0.69	5	31 557 310
63	5.7	1.09	5	31 557 311
75	6.7	1.54	5	31 557 312
90	8.0	2.23	5	31 557 313
110	9.9	3.31	5	31 557 314

## Sockets Plain

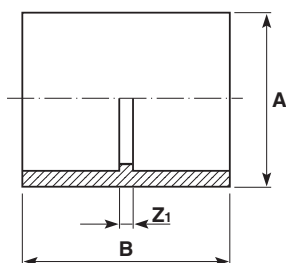

Size	A	B	Z <sub>1</sub>	gms	Code
16	21	31	3	5	31 100 305
20	25	36	3	7	31 100 306
25	31	41	3	12	31 100 307
32	40	48	3	25	31 100 308
40	50	58	3	45	31 100 309
50	62	68	3	77	31 100 310
63	78	81	3	154	31 100 311
75	93	93	3	230	31 100 312
90	111	110	4	380	31 100 313
110	136	132	6	690	31 100 314

## Reducing bushes Plain

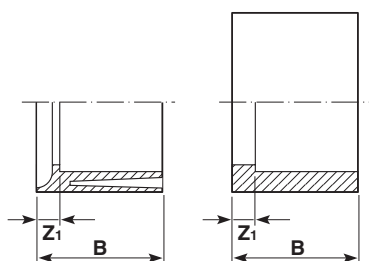
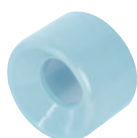

Size	B	Z <sub>1</sub>	gms	Code
20-16	17	3	2	31 109 412
25-20	19	3	4	31 109 415
32-16	23	9	5	31 109 417
32-25	23	4	6	31 109 419
40-32	27	5	13	31 109 423
50-20*	32	16	32	31 109 424
50-25*	32	13	29	31 109 425
50-32	32	10	19	31 109 426
50-40	32	5	25	31 109 427
63-25*	38	19	60	31 109 429
63-32*	39	16	36	31 109 430
63-50	39	7	47	31 109 432
75-63	45	7	65	31 109 438
90-50*	53	7	200	31 109 442
90-63*	54	15	224	31 109 443
90-75	54	8	110	31 109 444
110-63*	64	25	252	31 109 449
110-90	64	10	200	31 109 451

\*Configuration shown in inset.

For an example of the use of reducing bushes see page 21.

## Reducers Plain/spigot

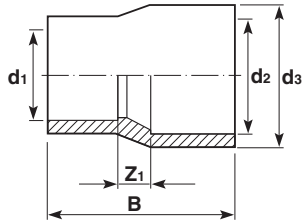

d <sub>3</sub>	d <sub>2</sub>	d <sub>1</sub>	B	Z <sub>1</sub>	gms	Code
25-	20-	16	37	6	6	31 114 412
32-	25-	20	42	6	12	31 114 415
40-	32-	25	50	8	22	31 114 419
50-	40-	32	60	10	39	31 114 423
63-	50-	40	71	12	80	31 114 427
75-	63-	50	85	14	108	31 114 432
90-	75-	63	97	13	190	31 114 438
110-	90-	75	114	15	350	31 114 444

For an example of the use of reducers see page 21.

## Elbows 45° Plain

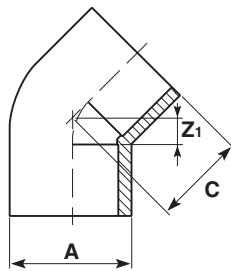

Size	A	C	Z <sub>1</sub>	gms	Code
16	21	19	5	5	31 119 305
20	25	22	6	7	31 119 306
25	31	26	7	14	31 119 307
32	40	31	8	27	31 119 308
40	50	38	10	54	31 119 309
50	62	45	13	100	31 119 310
63	78	54	15	180	31 119 311
75	93	64	18	300	31 119 312
90	112	76	23	550	31 119 313
110	136	90	26	950	31 119 314

## Elbows 90° Plain

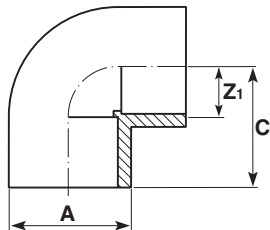

Size	A	C	Z <sub>1</sub>	gms	Code
16	21	24	10	6	31 115 305
20	25	28	12	10	31 115 306
25	31	33	14	17	31 115 307
32	40	40	18	35	31 115 308
40	50	49	22	68	31 115 309
50	62	60	27	129	31 115 310
63	78	73	34	230	31 115 311
75	93	86	40	385	31 115 312
90	111	102	49	690	31 115 313
110	136	124	60	1220	31 115 314

## Bends 90° Short radius

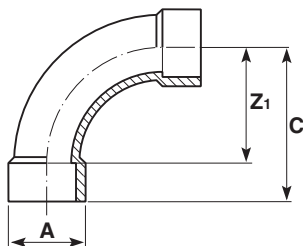

Size	A	C	Z <sub>1</sub>	gms	Code
16	21	47	32	12	31 118 305
20	26	57	40	18	31 118 306
25	33	69	50	38	31 118 307
32	41	87	64	75	31 118 308
40	51	107	80	135	31 118 309
50	62	132	100	245	31 118 310
63	78	165	126	470	31 118 311
75	93	195	150	810	31 118 312
90	111	234	180	1350	31 118 313
110	140	284	220	2570	31 118 314

### Dropper bends 180° Plain

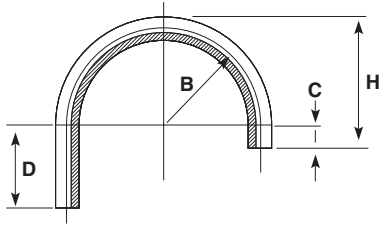

Size	B	C	D	H	Dev length	gms	Code
16	64.0	17.0	90.0	73.0	308	20	31 312 305
20	70.0	20.0	90.0	80.0	329	28	31 312 306
25	75.0	23.0	90.0	85.5	348	36	31 312 307
32	96.0	26.0	160.0	144.0	487.6	136	31 312 308

### Tees 90° Equal

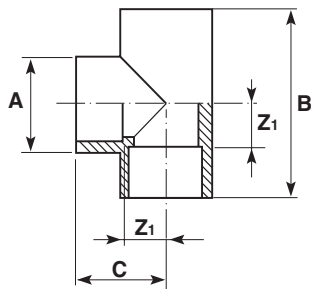

Size	A	B	C	Z <sub>1</sub>	gms	Code
16	21	47	24	10	7	31 122 305
20	25	56	28	12	12	31 122 306
25	31	67	33	14	24	31 122 307
32	40	81	41	18	48	31 122 308
40	50	98	49	22	87	31 122 309
50	62	119	60	27	160	31 122 310
63	78	146	73	34	300	31 122 311
75	93	172	86	40	510	31 122 312
90	111	204	102	49	900	31 122 313
110	136	248	124	60	1650	31 122 314

### Tees 90° Reducing

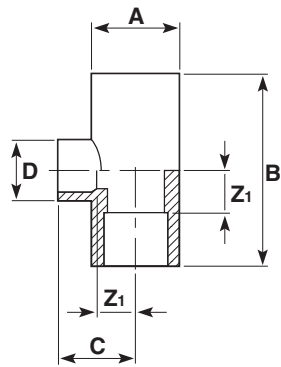

Size	A	B	C	D	Z <sub>1</sub>	gms	Code
20-16	25	56	26	21	12	12	31 124 412
25-16	31	67	28	21	14	22	31 124 414
25-20	31	67	31	25	14	22	31 124 415
32-16	40	81	32	21	18	40	31 124 417
32-20	40	81	35	25	18	40	31 124 418
32-25	40	81	37	31	18	41	31 124 419
40-20	50	98	39	25	22	72	31 124 421
40-25	50	98	41	31	22	72	31 124 422
40-32	50	98	45	40	22	74	31 124 423
50-20	62	119	44	29	27	140	31 124 424
50-25	62	119	46	31	27	140	31 124 425
50-32	62	119	50	40	27	140	31 124 426
63-25	78	146	53	31	34	250	31 124 429
63-32	78	146	57	40	34	250	31 124 430
63-50	78	146	67	62	34	270	31 124 432

### End caps Plain

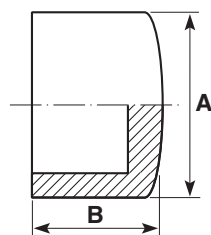

Size	A	B	gms	Code
16	21	17	3	31 149 305
20	25	21	5	31 149 306
25	32	24	8	31 149 307
32	41	29	19	31 149 308
40	50	35	30	31 149 309
50	62	41	53	31 149 310
63	78	50	106	31 149 311

## Socket unions Plain

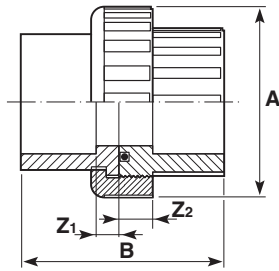

Size	A	B	Z <sub>1</sub>	Z <sub>2</sub>	gms	Code
16	33	42	3	10	19	31 205 305
20	41	47	3	10	29	31 205 306
25	50	53	3	10	46	31 205 307
32	57	64	9	10	70	31 205 308
40	72	78	10	12	140	31 205 309
50	80	92	12	14	154	31 205 310
63	102	112	14	18	270	31 205 311

O-Ring gasket EPDM rubber, (13209) as standard. Viton (FPM) O-Rings for conversion are available (13211).

## Sockets Plain/BSP taper female threaded, reinforced

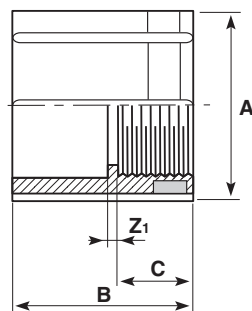
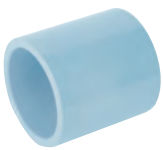

Size	A	B	C	Z <sub>1</sub>	gms	Code
20 x 1/2*	28	36	16	4	12	31 101 306
25 x 3/4*	36	40	18	4	19	31 101 307
32 x 1*	43	47	21	4	40	31 101 308

\*Threaded size designation.

## Female threaded adaptors BSP taper female threaded reinforcing band

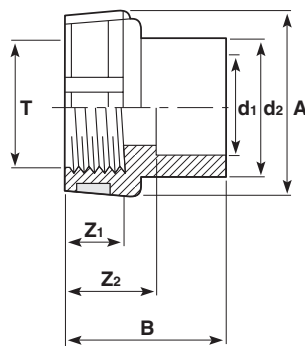

Size	d <sub>2</sub>	d <sub>1</sub>	T*	A	B	Z <sub>1</sub>	Z <sub>2</sub>	gms	Code
16-12-	3/8			23	28	11	16	7	31 153 331
20-16-	1/2			28	34	15	20	14	31 153 333
25-20-	3/4			35	39	16	22	21	31 153 335
32-25-	1			44	46	19	26	42	31 153 337
40-32-	1 1/4			55	54	21	31	69	31 153 339
50-40-	1 1/2			63	60	21	32	108	31 153 341
63-50-	2			78	72	26	39	169	31 153 343

\*Thread size designation. For spigot and socket jointing.

For an example of the use of female threaded adaptors see page 21.

## Female composite unions ABS/brass, BSP parallel female thread

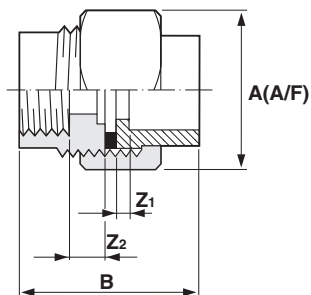
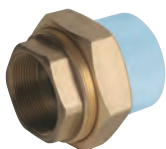

Size	A	B	Z <sub>1</sub>	Z <sub>2</sub>	gms	Code
16 x 3/8*	32	37	3	9	100	31 216
305						
20 x 1/2*	40	42	3	9	165	31 216 306
25 x 3/4*	48	48	3	10	250	31 216 307
32 x 1*	55	59	9	31	310	31 216 308
40 x 1 1/4*	65	68	10	11	450	31 216 309
50 x 1 1/2*	78	76	12	12	800	31 216 310
63 x 2*	88	90	14	14	950	31 216 311

\*Thread sizes designation. Brass retaining nut & EPDM rubber seal.

### Male composite unions ABS/brass, BSP taper male thread

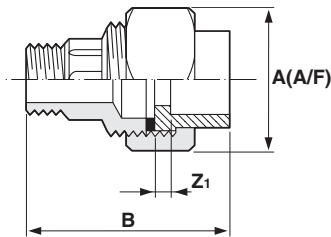
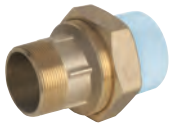

Size	A	B	Z <sub>1</sub>	gms	Code
16 x 3/8*	32	48	3	105	31 217 305
20 x 1/2*	40	54	3	175	31 217 306
25 x 3/4*	48	74	3	320	31 217 307
32 x 1*	55	86	8	420	31 217 308
40 x 1 1/4*	65	93	10	620	31 217 309
50 x 1 1/2*	78	109	12	1000	31 217 310
63 x 2*	88	125	14	1200	31 217 311

\*Thread sizes designation. Brass retaining nut & EPDM rubber seal.

### Wall brackets ABS/brass body

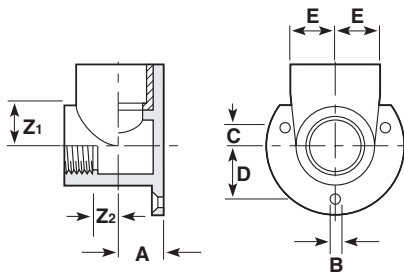

Size	A	B	C	D	E	Z <sub>1</sub>	Z <sub>2</sub>	gms	Code
16-3/8*	15	4.5	6	19	18.0	17	9	180	31 422 326
20-1/2*	16.5	4.5	6	19	19.5	18	9	185	31 422 327
25-1/2*	20	4.5	5	24	22.5	19	11	215	31 422 328
25-3/4*	20	4.5	5	24	22.5	19	11	200	31 422 329

\*Thread sizes designation. Bolt/Screw size M5/2BA/No.10.

### Wall brackets Multiport, aluminium

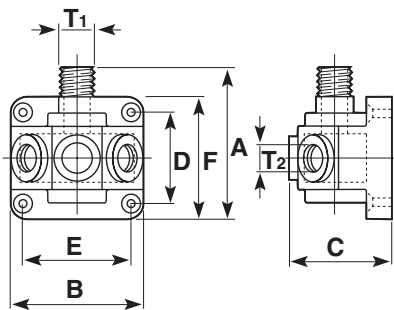

Size	A	B	C	D	E	F	T <sub>1</sub> BSP	T <sub>2</sub> BSP	gms	Code
3/4 x 1/2	76	84	94	56	65	56	3/4	1/2	330	31 429 122

Bolt/Screw size M5/2BA/No.10.

### Flanges stub Serrated face

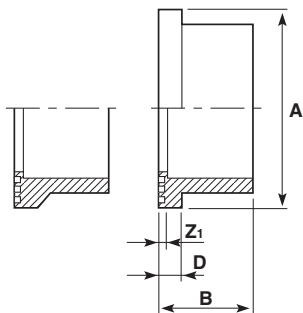

Size	A	B	D	Z <sub>1</sub>	gms	Code
32	50	29	10	6	19	31 135 308
40	61	35	8	3	36	31 135 309
50	73	40	8	3	60	31 135 310
63	90	47	14	8	100	31 135 311
75	106	53	15	8	150	31 135 312
90	125	64	16	10	240	31 135 313
110	150	75	18	11	370	31 135 314

## Flanges blanking Plain/drilled

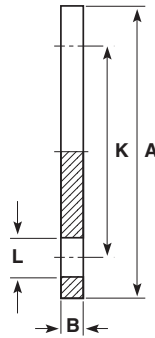

BS 4504: 16/3 (DIN 2501 16 bar/PN16)

No. Size	A	B	K	L	No. Holes	gms	Code
32	115	13	85	14	4	139	11 323 308
40	140	13	100	18	4	204	11 323 309
50	150	13	110	18	4	237	11 323 310
63	165	20	125	18	4	447	11 323 311
75	185	20	145	18	4	568	11 323 312
90	200	20	160	18	8	645	11 323 313
110	210	20	180	18	8	715	11 323 314

Blanking flanges are manufactured from grey ABS and must be used with the appropriate backing ring.

## Backing rings Galvanised mild steel. Drilled to DIN 2501: Sheet 1: 1972 (BS4504: Section 1: 1989 Table II)

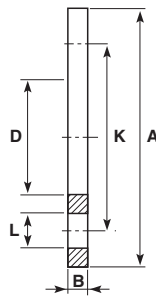

BS 4504: 16/3 (DIN 2501 16 bar/PN16)

No. Size	A	B	K	L	No. Holes	gms	Code
32	115	6	85	14	4	394	13 421 308
40	140	6	100	18	4	579	13 421 309
50	150	6	110	18	4	641	13 421 310
63	165	8	125	18	4	976	13 421 311
75	185	8	145	18	4	1204	13 421 312
90	200	8	160	18	8	1245	13 421 313
110	220	8	180	18	8	1383	13 421 314

## Gaskets flat Stub flange EPDM



Size	A	B	gms	Code
32	50	2	4	13 411 308
40	71	2	4	13 411 309
50	73	2	7	13 411 310
63	90	3	10	13 411 311
75	106	3	20	13 411 312
90	125	3	30	13 411 313
110	150	4	40	13 411 314

## Flange assembly kits



Pre-packed flange assembly kits consist of an Air-Line Xtra stub flange, galvanised mild steel backing ring and gasket together on one code. Ordering these products guarantees a correct fit between components. See the Industrial Price List for further details.

Size	Code
32	31 364 308
40	31 364 309
50	31 364 310
63	31 364 311
75	31 364 312
90	31 364 313
110	31 364 314

## Valve support plates Galvanised mild steel. Drilled to DIN 2501: Sheet 1: 1972 (BS4504: Section 1: 1989 Table II)

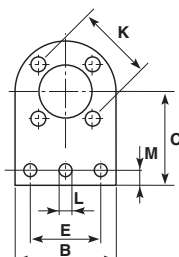

Size	B	C	E	K	L	M	N	No. Holes	gms	Code
32	115	98	76	85	14	16	2	4	860	31 459 308
50	150	127	100	110	18	22	2	4	1480	31 459 310
63	165	134	100	125	18	22	2	4	2100	31 459 311
75	185	143	126	145	18	22	2	4	2500	31 459 312
90	200	150	126	160	18	22	2	8	2660	31 459 313
110	220	159	152	180	18	22	3	8	2960	31 459 314

## Valves

### VKD Double union ball valves Manual – Plain sockets with EPDM seals

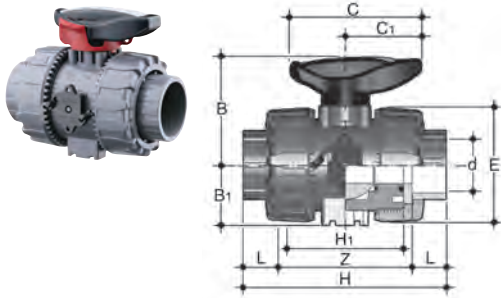

d	DN	PN	L	Z	H	E	B	C	Weight gms	Code
16	10	16	14	75	103	55	49	66	200	HO DKA 305
20	15	16	16	71	103	55	49	66	195	HO DKA 306
25	20	16	19	77	115	66	59	75	310	HO DKA 307
32	25	16	22	84	128	75	66	85	440	HO DKA 308
40	32	16	26	94	146	87	75	97	645	HO DKA 309
50	40	16	31	102	164	100	87	110	880	HO DKA 310
63	50	16	38	123	199	122	101	134	1490	HO DKA 311

Options:

*FPM seals (plain ends) order HO DKB \*\*\**

*For threaded versions refer to Imperial Valves section.*

Manual valves can be supplied with locking kits - further information is available from our Valve Department.

### FK Butterfly valves Glass reinforced polypropylene with ABS disc

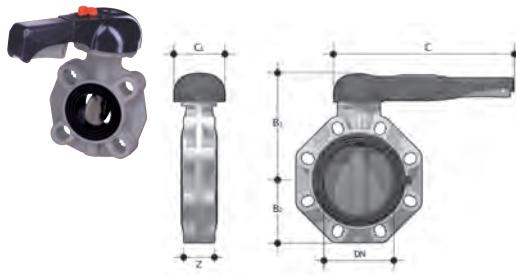

lever operated

d	DN	PN	B <sub>2</sub>	B <sub>3</sub>	C	C <sub>1</sub>	gms	U	Z	Code
50	40	16	60	137	175	100	900	4	33	HO FKA 106
63	50	16	70	143	175	100	1080	4	43	HO FKA 107
75	65	10	80	164	272	110	1470	4	46	HO FKA 108
90	80	10	93	178	272	110	1870	8	49	HO FKA 109
110	100	10	107	192	272	110	2220	8	56	HO FKA 110

U = No. of holes

Options:

*FPM seals order HO FKB\*\*\**

### VM Diaphragm valves Manual – plain spigot ends, Nitrile diaphragm

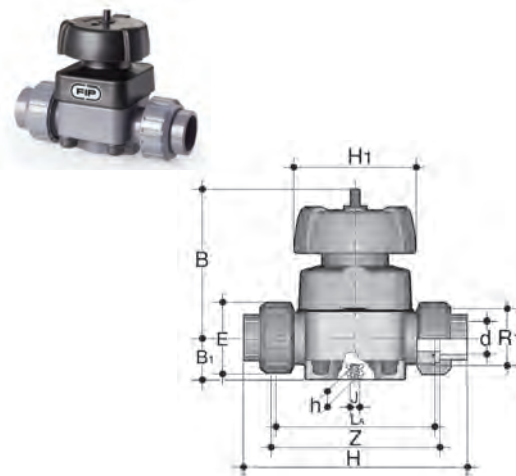

d	DN	PN	B	B <sub>1</sub>	H	h	H <sub>1</sub>	J	L	gms	Code
20	15	10	95	26	124	12	90	M6	16	700	HO UMA 306
25	20	10	95	26	144	12	90	M6	19	700	HO UMA 307
32	25	10	95	26	154	12	90	M6	23	700	HO UMA 308
40	32	10	126	40	174	18	115	M8	27	1500	HO UMA 309
50	40	10	126	40	194	18	115	M8	32	1500	HO UMA 310
63	50	10	148	40	224	18	140	M8	39	2400	HO UMA 311
75	65	10	225	55	284	23	215	M12	44	7000	HO VMA 412
90	80	10	225	55	300	23	215	M12	51	7000	HO VMA 413
110	100	10	295	69	350	23	250	M12	61	10500	HO VMA 414

Options:

*FPM diaphragm order HO VMB\*\*\**

*PTFE diaphragm order HO VMC\*\*\**

Manual Valves can be supplied with locking kits - further information is available from our Valve Department.

\*Note: 75mm, 90mm and 110mm are spigot ended.



## Accessories

### Cobra pipe clips

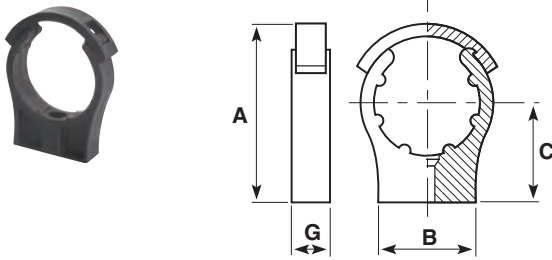

Size	A	B	C	G	Bolt/screw size	gms	Code
*16	–	35	25	16	M4/3BA/No 8	7	13 434 305
*20	–	35	30	16	M5/1BA/No 10	8	13 434 306
*25	–	35	35	17	M5/1BA/No 10	11	13 434 307
32	–	40	40	17	M5/1BA/No 10	14	13 434 308
40	–	45	45	20	M5/1BA/No 10	21	13 434 309
50	85	50	50	21	M6/OBA/No 10	30	13 434 310
63	102	60	60	21	M6/OBA/No 10	42	13 434 311
75	122	70	70	31	M8	94	13 434 312
90	148	80	90	31	M8	121	13 434 313
110	171	90	96	35	M8	185	13 434 314

\*Without retaining clip. Bolts/screws not supplied.

### Air-Line Xtra solvent cement



ML	Code
500	31 464 395

Note: Use only Durapipe Air-Line Xtra solvent cement for jointing the Durapipe Air-Line Xtra system.

### Eco cleaner



Litres	Code
0.5	03 463 395

### Chamfering and de-burring tools



Description	Product code
$\frac{3}{8}$ " to 1" pipe inner and outer milling cutter tool	FT 55 72 90
$\frac{3}{8}$ " to 2" pipe inner and outer milling cutter tool	FT 55 65 12
$\frac{3}{4}$ " to 6" chamfering tool	FT 55 05 10

### Pipe cutters



Description	Product code
$\frac{3}{8}$ " to 2" pipe cutter	FT 80 00 01
1 $\frac{1}{2}$ " to 4" pipe cutter	FT 80 00 03
$\frac{3}{8}$ " to 2" spare cutter wheel	FT 80 00 02
1 $\frac{1}{2}$ " to 4" spare cutter wheel	FT 80 00 04

## Durapipe UK Pipework Systems

### INDUSTRIAL



#### ABS

- Ideal for chilled, potable and waste water
- Tough, durable, lightweight and fully approved
- Suitable for use from -40°C to +70°C
- Fully matched system of pipes, fittings and valves



#### PVC-U

- Versatile, multi-purpose solvent weld pipework system with an extensive range of valves and fittings
- The established system for process and industrial handling of chemicals and water up to 60°C



#### Guardian

- Specialist dual contained pipework
- Patented Centra-Lok™ system
- Visual or automated leak detection system available

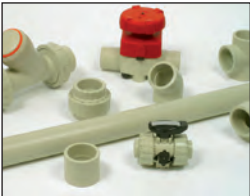

#### Polypropylene

- Conveys chemicals at temperatures up to 100°C
- Excellent resistance to a wide range of substances
- Available in larger diameters up to 500mm



#### Corzan

- Solvent weld thermoplastic pipe system for aggressive substances
- Designed specifically for use in highly corrosive conditions at temperatures up to 95°C
- Valves range available



#### Flow Control

- Manual and actuated flow control solutions
- For use with all Durapipe systems
- Lightweight and easy to install

### BUILDING SERVICES



#### Vulcathene

- Safe chemical drainage pipework
- Two easy jointing methods - Mechanical or Enfusion
- Ideal for schools, universities and colleges, hospitals and clinics



#### Friaphon

- Sound attenuated drainage system
- Superb sound insulation with no lagging required
- Ideal for hospitals, hotels, office suites and apartments



#### Duracool

- Pre-insulated ABS pipework system
- Lightweight and easy to install
- Unique shells for cost-efficient installation



#### SuperFLO

- Pipe system for chilled and cold water applications
- Ductile and robust down to minus 40°C
- Lightweight, non-corrosive and limescale resistant



#### Friatherm

- Limescale and corrosion resistant
- WRAS approved
- Installed cost saving versus traditional materials

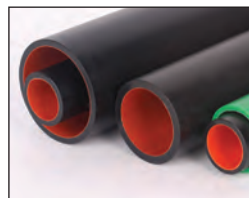

#### PLX

- Specialist pipework system for the safe conveyance of fuel
- Suitable for pressure and vacuum applications
- Ideal for emergency power supply, uninterrupted power supply and transport refuelling applications

## DURAPIPE UK CONDITIONS OF SALE

1. **DEFINITIONS:**  
 'Seller' shall mean Glynwed Pipe Systems Limited, registered in England under number 1698059. 'Buyer' shall mean any company, organisation or individual to whom a quotation is offered, or whose order is accepted by the Seller.
2. **CONDITIONS:**  
 All offers, quotations, estimates, acceptances and contracts are subject to these Conditions of Business and any terms or conditions which any other person shall seek to impose or make part of any contract shall, so far as is inconsistent with these Conditions of Business, not apply unless expressly agreed by the Seller in writing. The headings in these conditions are for convenience only and shall not affect their interpretation.
3. **QUOTATIONS AND PRICE VARIATION:**
  - a) Any quotation given by the Seller is an invitation to the Buyer to make an offer only and no order of the Buyer placed with the Seller in pursuance of a quotation or otherwise shall be binding on the Seller unless and until it is accepted in writing by the Seller.
  - b) Unless stated otherwise, all quotations and published price lists are ex works, exclusive of VAT and shall remain valid for 30 days or such a period as may be quoted but nevertheless the Seller may amend or withdraw any quotation by written or oral notice. Quotations may be varied if the Buyer makes variations in his specifications.
4. **STATEMENTS OR REPRESENTATIONS TO THE BUYER:**  
 If any statement or representation has been made to the Buyer upon which the Buyer relies other than in the documents enclosed with the Seller's quotation, the Buyer must set out that statement or representation in a document to be attached to or endorsed on the order in which case the Seller may submit a new quotation.
5. **DELIVERY - TIME:**
  - a) Any period for delivery given at any time and in any manner by the Seller is an estimate only and is not binding on the Seller. Delivery periods are normally calculated from the later of:
    - i) acceptance of order; or
    - ii) where applicable, the receipt by the Seller of a detailed specification or drawings.
  - b) Time shall not be deemed to be of the essence of the contract. Failure by the Seller to meet any quoted delivery period for any part or the whole of the order shall not entitle the Buyer to rescind the contract or to claim damages of any nature.
  - c) The Seller will endeavour to comply with reasonable requests by the Buyer for postponement of delivery but shall be under no obligation to do so. Where delivery is postponed otherwise than due to default by the Seller the Buyer shall pay all costs and expenses including a reasonable charge for storage and transportation occasioned thereby and an extra charge for split delivery if applicable.
  - d) The Buyer will receive delivery of any consignment between the hours of 8.00am and 4.00pm Monday to Friday inclusive, unless otherwise agreed in writing. Cost incurred by the Seller arising from the Buyer's refusal to accept consignments within the agreed hours shall be borne by the Buyer.
6. **DELIVERY AND RISK:**
  - a) Except where stated to the contrary in the contract, delivery shall be made as follows:
    - i) where the Buyer provides the transport, delivery shall be made ex the Seller's works;
    - ii) where the Seller provides the transport, delivery shall be made to the premises of the Buyer, or the premises of the Buyer's customer or works site if the Buyer has requested delivery to be so made but where the Buyer has made such a request the Seller will make a first delivery to the Buyer's customer or works site as so much of the goods as is available for that delivery but subsequent deliveries will be made to the premises of the Buyer.
  - b) The Seller may at its discretion make partial delivery of orders and invoice the same.
  - c) Risk in the goods shall pass on delivery.
  - d) Where goods are sent FOB the Seller's responsibility shall cease when the goods are placed on board ship or aircraft without the need for the Seller to give notice to the Buyer and the provisions of Section 32(3) of the Sale of Goods Act 1979 shall not apply.
7. **OWNERSHIP OF GOODS:**
  - a) The goods shall remain the sole and absolute property of the Seller as legal and equitable owner until such time as the Buyer shall have paid to the Seller the contract price together with the full price of any other goods the subject of any contract between the Seller and the Buyer.
  - b) The Buyer acknowledges that until such time as the property in the goods passes to the Buyer he is in possession of the goods as a bailee and fiduciary agent for the Seller and the Purchaser shall store the goods in such a manner that they are clearly identifiable as the property of the Seller.
  - c) Until payment due under all contracts between the Buyer and the Seller had been made in full, in the event of sale of the goods by the Buyer:
    - i) the Seller shall be entitled to trace all proceeds of sale received by the Buyer through any bank or other account maintained by the Buyer; and
    - ii) the Buyer shall if requested by the Seller in writing to so assign its rights to recover the selling price of the goods from the third parties concerned. Such monies to be held separately by the Buyer as agent on behalf of the Seller.
  - d) The Seller may for the purpose of recovery of its goods enter upon any premises where they are stored or where they are reasonably thought to be stored and may repossess the same.
8. **TERMS OF PAYMENT:**  
 In the event of default in payment according to the agreed payment terms between the Seller and the Buyer – ie: by the end of the month following the month of despatch of the goods the Seller shall be entitled without prejudice to any other right or remedy to suspend all further deliveries and to charge interest on any amount outstanding at the rate of 2% per month until payment in full is made (a part of a month being treated as a full month for the purpose of calculating interest).
9. **SHORTAGES AND DEFECTS APPARENT ON DELIVERY:**
  - a) It shall be the responsibility of the Buyer to inspect or arrange for an inspection of the goods on delivery whether the goods are delivered to the Buyer's premises or to the premises of the Buyer's customer or to a works site. If no such inspection is made the Buyer shall be deemed to have accepted the goods.
  - b) The Buyer shall have no claim for shortages or defects apparent on inspection unless:
    - i) a written complaint is made to the Seller within three days of receipt of the goods specifying the shortage or defect; and
    - ii) the Seller is within seven days of receipt of the complaint given an opportunity to inspect the goods and investigate the complaint before any use is made of the goods.
  - c) If a complaint is not made to the Seller as herein provided then in respect of such shortages or defects the goods shall be deemed to be in all respects in accordance with the contract and the Buyer shall be bound to pay for the same accordingly.
10. **CLAIMS FOR DEFECTS NOT APPARENT ON INSPECTION:**
  - a) The Buyer shall have no claim for defects not apparent on inspection unless the Seller is notified of defective workmanship or materials within twelve months from delivery of the goods. Provided that the goods have been installed and applied in accordance with any relevant recommendations made by the Seller, the Seller will at its option replace the goods or refund the net invoiced price in respect of the goods which have been shown to be defective. If the Seller does so supply substitute goods the Buyer shall be bound to accept such substituted goods in full satisfaction of the obligations of the Seller under the contract.
  - b) The Buyer shall in any event have no claim or set-off in respect of defects unless a written complaint is sent to the Seller as soon as the defect is noticed and no use is made of the goods thereafter or alteration made thereto by the Buyer before the Seller is given an opportunity to inspect the goods.
  - c) The Buyer is responsible for ensuring that the goods are fit for any particular purpose, and no warranty or condition of fitness for any particular purpose is to be implied into the contract.
11. **LIABILITY:**  
 Save as stated in Conditions 9 and 10 (and save in respect of death or personal injury resulting from the negligence of the Seller its servants or agents) the Seller shall not be liable for any claim or claims for direct or indirect consequential or incidental injury loss or damage made by the Buyer against the Seller whether in contract or in tort (including negligence on the part of the Seller its servants or agents) arising out of or in connection with any defect in the goods or their fitness or otherwise for any particular purpose or any act omission neglect or default of the Seller its servants or agents in the performance of the contract.
12. **FORCE MAJEURE:**  
 Notwithstanding anything herein contained neither the Buyer nor the Seller is to be held liable for any delay or failure to carry out the contract due wholly or in part to an act of God action by any Government whether British or foreign civil war strikes and/or lockouts whatsoever occurring fire trade disputes floods or unfavourable weather or any material becoming unavailable or irreplaceable (whether at all or at commercially acceptable prices) or any other circumstances beyond the control of the Seller.
13. **SUB-CONTRACTING:**  
 The Seller reserves the right to sub-contract the fulfilment of any order or any part thereof.
14. **INSOLVENCY AND BREACH OF CONTRACT:**  
 In the event that:
  - a) the Buyer commits any breach of the contract and fails to remedy such breach (if capable of remedy) within a period of thirty days from receipt of a notice in writing from the Seller requesting such remedy; or
  - b) any distress or execution is levied upon any of the goods or property of the Buyer; or
  - c) the Buyer offers to make any arrangements with or for the benefit of its creditors or (if an individual) becomes subject to a petition for a bankruptcy order or (being a limited company) has a receiver appointed of the whole or any part of its undertaking property or assets; or
  - d) an order is made or a resolution is passed or analogous proceedings are taken for the winding up of the Buyer (save for the purpose of reconstruction or amalgamation with insolvency and previously approved in writing by the Seller) the Seller shall thereupon be entitled without prejudice to its other rights hereunder forthwith to suspend all further deliveries until the default has been made good or to determine the contract and any unfulfilled part thereof or at the Seller's option to make partial deliveries. Notwithstanding any such termination the Buyer shall pay to the Seller at the contract rate for all the goods delivered up to and including the date of termination.
15. **INDUSTRIAL PROPERTY RIGHTS:**  
 If goods supplied by the Seller to the Buyer's design or specifications infringe or are alleged to infringe any patent or registered design right or copyright the Buyer will indemnify the Seller against all damages, costs and expenses incurred by the Seller as a result of the infringement or allegation. The Buyer will give the Seller all possible help in meeting any infringement claim brought against the Seller.
16. **BUYER'S ERROR IN ORDERING:**  
 In the event the Buyer orders incorrectly the Seller will be under no obligation to the Buyer to rectify or assist in rectifying the error.
17. **LAW AND JURISDICTION:**  
 The contract shall be subject in all respects to English Law and to the jurisdiction of the English Courts.

# Durapipe Air-Line Xtra

---

Compressed Air Distribution

Durapipe UK reserves the right to modify the details in this publication as products and specifications are updated and improved. The content of this publication is for general information only and it is the user's responsibility to determine the suitability of any product for the purpose intended.

For further information on all Durapipe UK products and services contact our Customer Services Department as detailed below.

#### Customer Services

Tel: +44 (0)844 800 5509

Fax: +44 (0)1543 471682

Durapipe UK is a trade name of Glynwed Pipe Systems Ltd. Company Number 1698059.

Registered office:

#### Durapipe UK

Hyssop Close

Swaffield Park

Cannock

Staffordshire

WS11 7FU

United Kingdom

Tel: +44 (0)1543 471680

Fax: +44 (0)1543 471682

email: [enquiries@durapipe.co.uk](mailto:enquiries@durapipe.co.uk)

web: [www.durapipe.co.uk](http://www.durapipe.co.uk)

Twitter: @DurapipeUK

Distributor

04900001 August 2018